

TA7
W34
no. DRP-94-4
c. 3

US Army Corps
of Engineers

DREDGING RESEARCH PROGRAM

TECHNICAL REPORT DRP-94-4

MONITORING OF WAVES AND CURRENTS NEAR THE ALABAMA DREDGED MATERIAL MOUNDS

by

David D. McGehee, James P. McKinney, William E. Grogg, Edward B. Hands

DEPARTMENT OF THE ARMY

Waterways Experiment Station, Corps of Engineers
3909 Halls Ferry Road, Vicksburg, Mississippi 39180-6199



September 1994

Final Report

Approved for Public Release; Distribution is Unlimited

Prepared for DEPARTMENT OF THE ARMY
U.S. Army Corps of Engineers
Washington, DC 20314-1000

Under Work Unit 32467

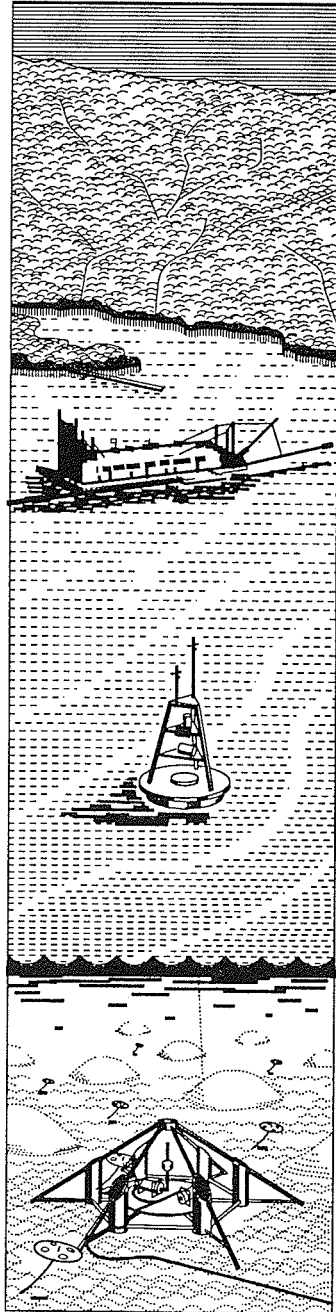

The Dredging Research Program (DRP) is a seven-year program of the U.S. Army Corps of Engineers. DRP research is managed in these five technical areas:

- Area 1 - Analysis of Dredged Material Placed in Open Water
- Area 2 - Material Properties Related to Navigation and Dredging
- Area 3 - Dredge Plant Equipment and Systems Processes
- Area 4 - Vessel Positioning, Survey Controls, and Dredge Monitoring Systems
- Area 5 - Management of Dredging Projects

The contents of this report are not to be used for advertising, publication, or promotional purposes. Citation of trade names does not constitute an official endorsement or approval of the use of such commercial products.



PRINTED ON RECYCLED PAPER

USACEWES



3 5925 00299 6277



US Army Corps
of Engineers
Waterways Experiment
Station

Dredging Research Program Report Summary

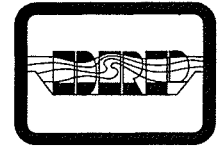

Monitoring of Waves and Currents Near the Alabama Dredged Material Mounds (TR DRP-94-4)

ISSUE: The U.S. Army Engineer District, Mobile, applied an innovative solution to disposal of dredged material from deepening navigation channels for Mobile Harbor that reduced cost and provided potential benefits. Two submerged mounds were constructed in the Gulf of Mexico: one was a deeper mound (approximately 50 ft) from fine material, and the other was a shallower mound (approximately 20 ft) from the coarser, beach-quality material.

RESEARCH: A monitoring study was performed by the U.S. Army Engineer Waterways Experiment Station (WES) Coastal Engineering Research Center (CERC) to assure compliance with local regulatory requirements, assess the characteristics of the constructed features, monitor the fate of the mounds, and document the interaction

between the two features and the hydrodynamic environment.

The monitoring study included periodic surveys, sediment analysis, and measurement of the environmental forcing functions; i.e. waves and currents. This report documents the implementation of and results from a wave and current data collection plan. For information on obtaining all or portions of the analyzed data set, contact the DRP Program Manager, cited below.

SUMMARY: Data were obtained from a CERC-designed, real-time automated system, commercially available self-recording instruments, and instrumented buoys operated by the National Data Buoy Center. Data were used to develop empirical relations for mound response and to provide input for numerical models of sediment transport processes.

US-CE-C Property of the
United States Government

About the Authors: Mr. David D. McGehee is a research hydraulic engineer, Mr. James P. McKinney is a mathematician, Mr. William E. Grogg is an equipment specialist, and Mr. Edward B. Hands is a research physical scientist at the Coastal Engineering Research Center, U.S. Army Engineer Waterways Experiment Station. For further information about the Dredging Research Program (DRP), contact Mr. E. Clark McNair, Jr., Manager, DRP, at (601) 634-2070.

RESEARCH LIBRARY
US ARMY ENGINEER WATERWAYS
EXPERIMENT STATION
VICKSBURG, MISSISSIPPI

31237001

Dredging Research Program

Technical Report DRP-94-4
September 1994

TA7
W34
no. DRP-94-4
c. 3

Monitoring of Waves and Currents Near the Alabama Dredged Material Mounds

by David D. McGehee, James P. McKinney, William E. Grogg, Edward B. Hands

U.S. Army Corps of Engineers
Waterways Experiment Station
3909 Halls Ferry Road
Vicksburg, MS 39180-6199

Final report

Approved for public release; distribution is unlimited

Prepared for U.S. Army Corps of Engineers
Washington, DC 20314-1000



**US Army Corps
of Engineers**
Waterways Experiment
Station

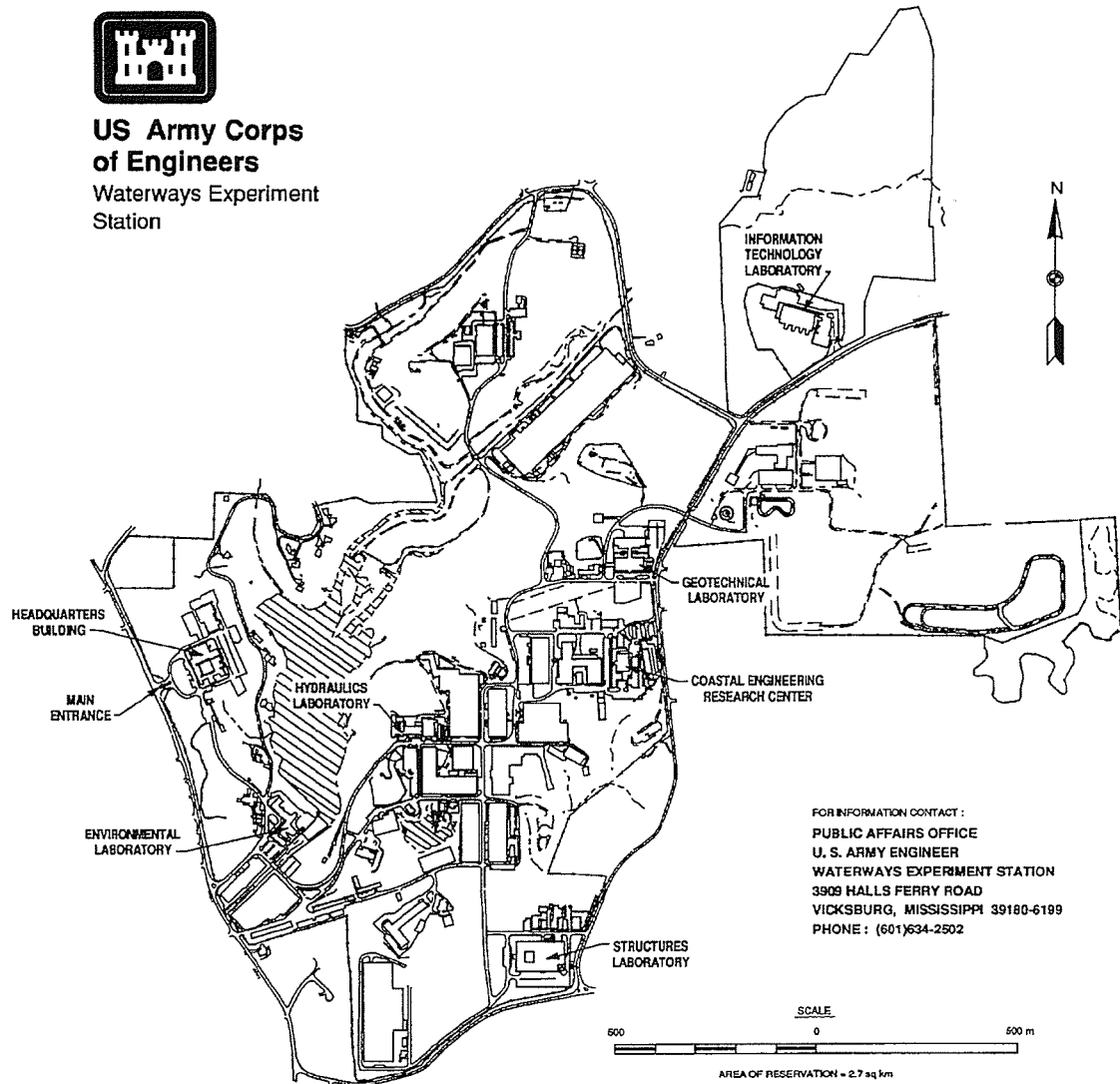

Waterways Experiment Station Cataloging-in-Publication Data

Monitoring of waves and currents near the Alabama dredged material mounds / by David D. McGehee ... [et al.] ; prepared for U.S. Army Corps of Engineers.

87 p. : ill. ; 28 cm. — (Technical report ; DRP-94-4)

Includes bibliographic references.

1. Spoil banks — Environmental aspects. 2. Ocean circulation — Statistics. 3. Dredging spoil — Environmental aspects. 4. Waste disposal in the ocean — Environmental aspects. I. McGehee, David D. II. United States. Army. Corps of Engineers. III. U.S. Army Engineer Waterways Experiment Station. IV. Dredging Research Program. V. Series: Technical report (U.S. Army Engineer Waterways Experiment Station) ; DRP-94-4.

TA7 W34 no.DRP-94-4

Contents

Preface	vii
Summary	ix
Conversion Factors, Non-SI to SI Units of Measurement	x
1—Introduction	1
Background	1
Purpose and Scope	1
2—Data Needs	4
3—Functional Constraints	7
Environmental Factors	7
Logistic Factors	8
Sensors	8
Schedule	10
Power	10
4—Data Management	11
Data Capture Plan	11
Data Quality Control	12
Spectral Analysis	13
Current Parameters	15
5—System Design	17
General	17
Internal Recording Gauges	17
NDBC Buoys	22
CERC Real-Time System	23
6—Results	32
Data Recovery	32
Failure Analysis	34
Conclusions	35

References	36
Plates 1-16	
Appendix A: Sensor Specifications	A1
Appendix B: Reduced Data	B1
Appendix C: Statistical Comparison of Adjacent Gauges	C1
Appendix D: Gauge Site Name Conversion Table	D1
Appendix E: Gauge Servicing Schedule	E1
Appendix F: Notation	F1
SF 298	

List of Figures

Figure 1. Location map of study	2
Figure 2. Area and gauge site map	5
Figure 3. Self-recording gauge in mount	11
Figure 4. Standard USCG buoy with elastic mooring - Site 1.1	20
Figure 5. Foam buoy with elastic mooring - Site 1.3	21
Figure 6. Standard NDBC 3-m buoy	22
Figure 7. CERC-designed SAU on mount	24
Figure 8. Signal processing flowchart for CERC-designed system	25
Figure 9. Power distribution flowchart for CERC-designed system	27
Figure 10. RTU and solar power system on gas well	28
Figure 11. CERC-designed PUV in trawler-resistant mount	30

List of Tables

Table 1. Data Recovery Schedule	18
Table 2. Power Budget	29

Preface

This report summarizes data collected in support of research into alternative placement of dredged material. The research was planned by the U.S. Army Engineer District, Mobile (SAM); the U.S. Army Corps of Engineers, Directorate of Civil Works; and the Coastal Engineering Research Center (CERC) of the U.S. Army Engineer Waterways Experiment Station (WES). Work was authorized under Work Unit 32467, "Field Techniques and Data Analysis to Assess Open Water Disposal Deposits" of the Dredging Research Program (DRP) of Headquarters, U.S. Army Corps of Engineers (HQUSACE). The HQUSACE Technical Monitors and Advisors for the DRP are Messrs. Robert H. Campbell, Barry W. Holliday, John H. Lockhart, John G. Housley, M. K. Miles, Gerald Greener, and John Sanda. Mr. E. Clark McNair is the DRP Program Manager, and Dr. Billy H. Johnson is the Technical Manager of Area 1, "Analysis of Dredged Material Placed in Open Waters," which includes Work Unit 32467. Mr. Edward B. Hands is the Principal Investigator of the Work Unit.

The data collection/analysis effort described in this report was conducted by the Prototype Measurement and Analysis Branch (PMAB) of the Engineering Development Division (EDD), CERC, under the direction of Mr. David McGehee. The measurement system was built and maintained by the Development Group, under the direction of Mr. William E. Grogg, and data were analyzed by Mr. James P. McKinney and Mr. Andrew Morang of the Data Analysis Group, under the direction of Mr. William D. Corson. Installation and repair of the system were conducted by the Operations Group under the direction of Mr. William M. Kucharski, assisted at times by personnel from the Coastal Structures and Evaluation Branch, EDD. Additional data were provided under interagency agreement by the National Data Buoy Center (NDBC) of the National Oceanic and Atmospheric Administration (NOAA). This report benefitted from extensive review and input from Mr. Hands.

Special thanks are extended to the U.S. Coast Guard (USCG) District, Mobile, CPO Donald Vinson, skipper, and the crew of the Coast Guard cutter "White Pine" for their ample assistance in the course of the study. Equally valuable were the vessels provided by the Dauphin Island Fishery Research Branch of the U.S. Public Health Service (PHS) and the expertise of Mr. Clinton Collier (PHS) and Mr. Billy Sprinkle, owner/skipper of the "Dream Girl II."

Work at CERC was conducted under the general supervision of Dr. James R. Houston, and Mr. Charles C. Calhoun, Director and Assistant Director, CERC, respectively; and under the direct supervision of Mr. Thomas W. Richardson, Chief, EDD, and Mr. William L. Preslan, Chief, PMAB.

At the time of publication of this report, Director of WES was Dr. Robert W. Whalin. Commander was COL Bruce K. Howard, EN.

For further information on this report or on the Dredging Research Program, contact Mr. E. Clark McNair, Jr., Program Manager, at (601) 634-2070.

The contents of this report are not to be used for advertising, publication, or promotional purposes. Citation of trade names does not constitute an official endorsement or approval of the use of such commercial products.

Summary

The U.S. Army Engineer District, Mobile, applied an innovative solution to disposal of dredged material from deepening navigation channels for Mobile Harbor that reduced cost and provided potential benefits. Two submerged mounds were constructed in the Gulf of Mexico - a deeper mound (approximately 50 ft) from clay-to-sand size material, and a shallower mound (approximately 20 ft) from the coarser, beach-quality material. A monitoring study was performed by CERC to assure compliance with local regulatory requirements, assess the characteristics of the constructed features, monitor the fate of the mounds, and document the interaction between the two features and the hydrodynamic environment.

The monitoring study included periodic surveys, sediment analysis, and measurement of the environmental forcing functions, i.e. waves and currents. This report documents the implementation of and results from a wave and current data collection plan. Data were obtained from a CERC-designed, real-time automated system, commercially available self-recording instruments, and instrumented buoys operated by the National Data Buoy Center. Sufficient data were obtained to develop empirical relations for mound response and to provide input for numerical models of sediment transport processes.

Conversion Factors, Non-SI to SI Units of Measurement

Non-SI units of measurement used in this report can be converted to SI units as follows:

Multiply	By	To Obtain
cubic yards	0.7645549	cubic meters
degrees (angle)	0.01745329	radians
feet	0.3048	meters
inches	2.54	centimeters
miles (U.S. nautical)	1.852	kilometers
miles (U.S. statute)	1.609347	kilometers
pounds (force)	4.448222	newtons
pounds (mass)	0.4535924	kilograms

1 Introduction

Background

Mobile is located at the northern shore of the Gulf of Mexico (Figure 1). Deepening of navigation channels for the Port of Mobile, Alabama, required removal of approximately 17 million cu yd¹ of material. The management plan called for placement of the dredged material in the open Gulf. An innovative approach was selected to reduce disposal costs by reducing transport distance, and possibly provide beneficial effects. Clay-to-sand size material from the deepening project was placed 5 miles offshore, in approximately 50 ft of water, to form a large, relatively stable mound. Monitoring objectives were to assure compliance with local regulatory requirements, assess the mounding characteristics of fine-grained material, and document the effects that such a large mound could have on incident waves and fisheries (McLellan and Imsand 1989). A smaller experimental mound, made of coarser, beach-quality sands, obtained from regularly scheduled entrance channel maintenance dredging, was constructed near an existing shoal 3 miles offshore. The objective of monitoring the shallower berm was to document the fate of beach-quality sand mounded at a depth below any previously observed feeder berms (Hands and Bradley 1989). For convenience, the deeper mound will be referred to as the stable berm, and the nearshore, experimental mound as the active berm (Figure 1).

Purpose and Scope

A monitoring study was performed by the U.S. Army Engineer Waterways Experiment Station, Coastal Engineering Research Center (CERC) to document the short-term response (several years) of the two mounds, the effect of the mounds on the local physical environment, and the environmental conditions that determined the fate of the placed material. Separate tasks were performed to periodically survey the two mounds to

¹ A table of factors for converting non-SI units of measurement to SI units is presented on page x.

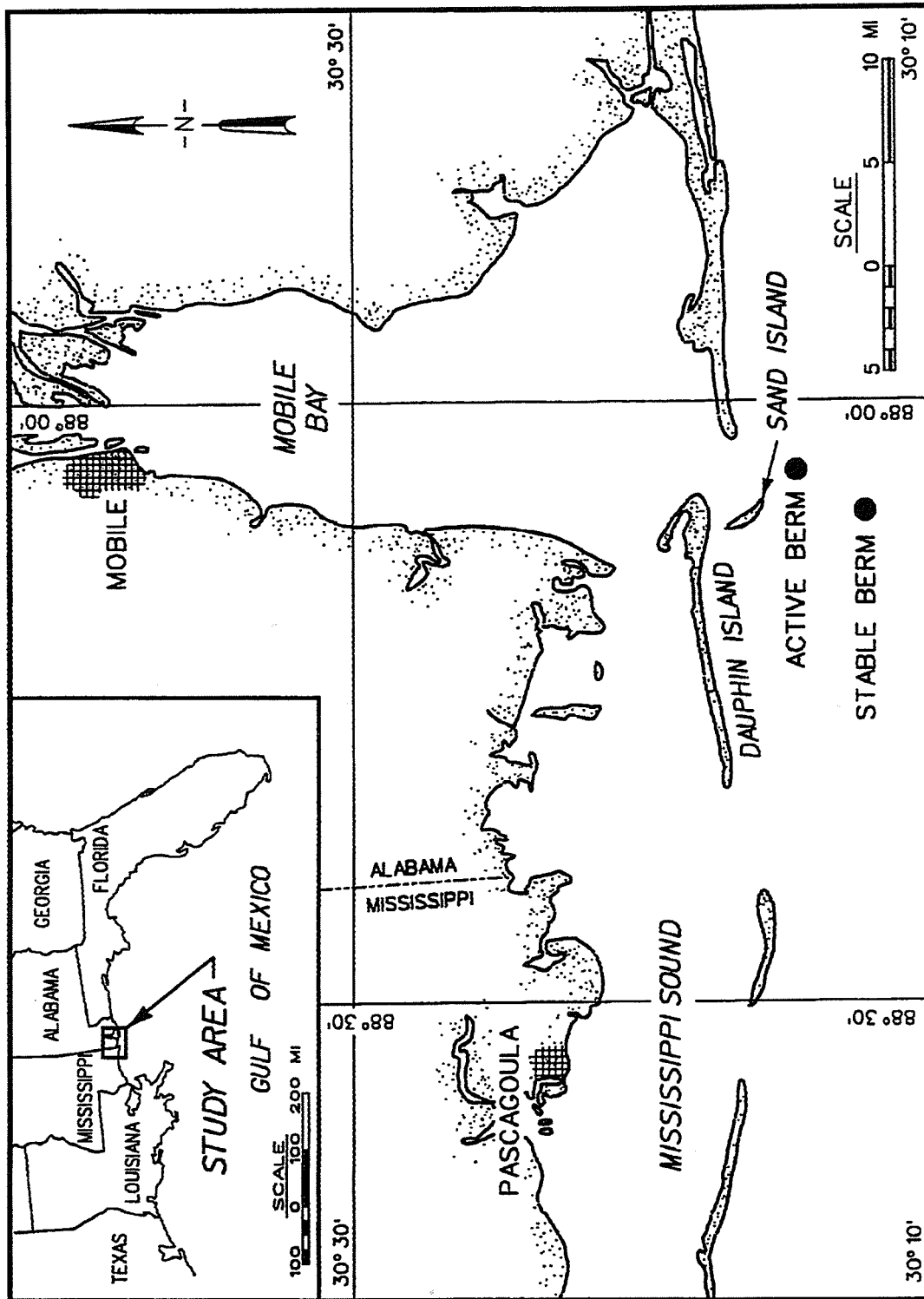

Figure 1. Location map of study

detect material loss, model the sediment transport processes, and monitor the environmental forcing functions. This report describes that portion of the overall study conducted by the CERC Prototype Measurement and Analysis Branch (PMAB) to measure and record the incident hydrodynamic forces at the site. The purpose of the report is to present and interpret the data collected by CERC, explain the design of the monitoring plan and the instrument systems used to collect data as a logical result of a systematic planning process, and discuss the lessons learned in meeting the challenges presented by the local environment.¹ Significance or implications of the hydrodynamic data, or a detailed uncertainty analysis of the measurements, will be discussed in later reports, e.g., Douglass, Resio, and Hands (in preparation). Resio and Hands (1994) analyze regional currents in the vicinity of the berms to illustrate techniques for interpreting seabed drifter and wind data from open-water monitoring sites. Placement of the active berm and its fate over a period of years are discussed in a series of reports beginning with Bradley and Hands (1989), Hands and Bradley (1989), Hands (1991a), Hands and Allison (1991), Hands (1991b), Hands (1992a), and Hands (1994). Plume dispersion and process measurements from August and September 1989 are given in Kraus (1991).

Development of a monitoring plan is an integrated effort that includes defining data needs, specifying functional requirements, developing a data management plan, and specifying or designing a measurement system to obtain the data (McGehee 1990, Hands 1992b). This sequence will be followed in the report, though in practice, the chronology may differ due to fiscal or logistic constraints. Chapter 2 shows how the type of data required follows from specific intended uses. The functional, i.e., physical and logistic, constraints described in Chapter 3 govern the selection of the sensor type and deployment/recovery methods. Chapter 4, "Data Management," includes the plans for capture, analysis, and final presentation of the data - factors that dictate instrument capabilities as well as software requirements. Chapter 5, "System Design," details the approach selected to obtain the final products within the constraints. Chapter 6 describes the results of the data collection effort, with discussions of data recovered and system performance. Appendices contain a detailed summary of the entire data set collected by CERC, in the form of tables of measured values by time, and technical specifications of hardware components. Appendix A contains sensor specifications, Appendix B contains a sample of reduced data for a typical deployment, and Appendix C is a statistical comparison of adjacent gauges. Appendix D is a gauge site name conversion table, Appendix E is a gauge servicing schedule, and Appendix F is a notation of symbols and abbreviations used in the report.

¹ Archived data from the NDBC buoys are available from the National Oceanographic Data Center (NODC), 1825 Connecticut Avenue, NW, Washington, DC 20235. Digital ASCII files of the wave and current time series and summary statistics based on analyzed directional spectra are available from the Dredging Research Program Manager at CERC.

2 Data Needs

Hydrodynamic data were collected to achieve the following four general objectives:

- a.* Provide input conditions for large-scale numerical models used to relate incident hydrodynamic conditions to measured response of the features.
- b.* Permit prediction of the long-term fate of the mounds at this site, as well as other potential nearshore disposal sites, by relating hydrodynamic climate to the long-term fate of the mounds.
- c.* Document the effect of the stable berm on the incident waves.
- d.* Provide data on sediment suspension and transport.

Submarine sediment is transported by water motions that are the result of wave-, tide-, and wind-induced currents. Wind and tide data were obtained from nearby land and offshore stations, and are not covered in this report. Objectives *a.* and *b.* required the measurement of directional wave and water current parameters at locations specified below. Objective *c.* required wave data only. Objective *d.* required accurate measurement of instantaneous water particle velocity at or near the bottom, where sediment transport is initiated. Setup- or storm-surge-induced local water depths are needed to meet all four objectives, because wave conditions depend strongly on depth. (A tidal measurement is a water surface elevation referenced to some tidal datum, such as mean lower low water, as opposed to a local water depth, which is relative to the (non-constant) seafloor.)

The four areas selected for monitoring are illustrated on Figure 2. Area 1, for the active berm, and Area 2, for the stable berm, are at about the same depth as the corresponding features, but sufficiently remote to be unaffected by either. Area 3 was designated to document, by comparison with Area 2, the reduction of the incident energy by the stable berm. To meet the 4th objective, measurements were made at the crest of the active berm, Area 4, where most transport was expected to occur. Actual gauge sites within these areas will be discussed in Chapters 5 and 6.

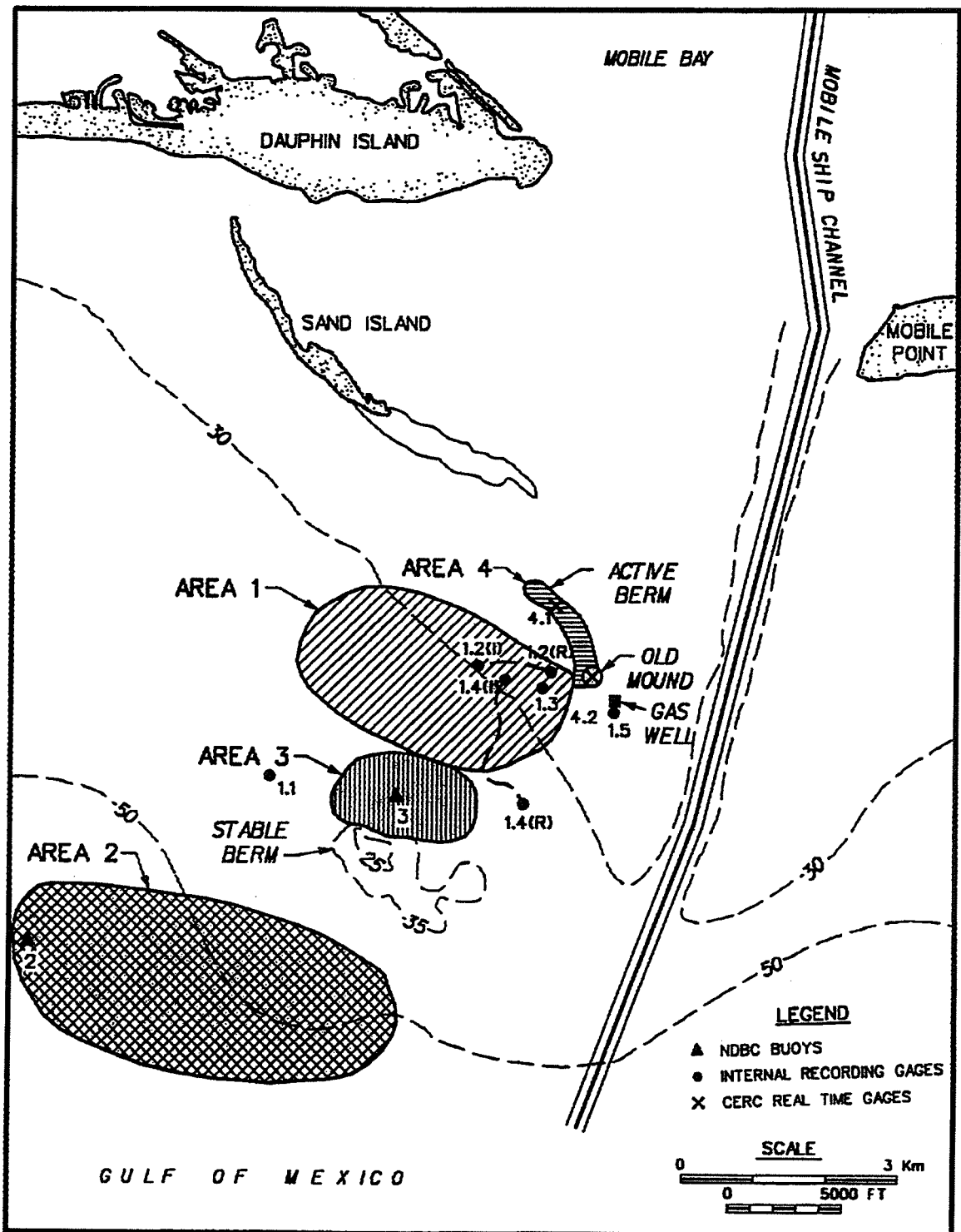

Figure 2. Area and gauge site map

The amount of data or length of deployment varies with each site. The Gulf of Mexico has a relatively mild wave climate with occasional extra-tropical storms (occurring most often in fall and winter), punctuated by extreme conditions caused by tropical storms and hurricanes. In order to capture data for the episodic events likely to cause sediment transport, it was necessary to monitor the sites continuously throughout the year. Periodic surveys or experiments would not suffice because these events occur randomly and instruments need to be in place before conditions become too violent for placement. Evolution of the mounds, if it occurred, was expected to be so gradual as to require several seasons to observe through comparison of successive bathymetric surveys. Finally, to make reliable estimates of the wave climate at the site for projection of future trends (Objective 2), several years of data are necessary to account for annual, as well as seasonal, variance. Area 2 represents the most "generic" site to document the wave climate before it is affected by the local bathymetry, and should be monitored for the longest period. It may prove possible to transform wave conditions from Area 2 to Area 1 by using properly calibrated wave transformation models, or by some empirical parametric relation. To validate such methods, there should be sufficient overlap of these two data sets to provide a range of conditions. Likewise, Areas 3 and 4 should be monitored for a sufficient length of time to provide a variety of conditions, from mild to energetic, but do not need to be monitored as long as Area 2.

Based on the above considerations, wave and current data are needed from at least four sites, on a regular, near-continuous basis, for periods ranging from a storm season to several years. To obtain the required data, instruments would have to be designed and installed, operate, and survive in a hostile environment, within specified time and fiscal limits.

3 Functional Constraints

Environmental Factors

The study site is located 3 to 6 n.m. offshore of Dauphin Island. The water depth varies from 13 ft at the crest of the active berm to 55 ft below mean low water in Area 2. Principal risks to equipment are from hurricane winds, surge, waves, and currents, and from commercial fishing boats pulling bottom-trawl nets. Normal ocean engineering considerations (corrosion, biofouling, pressure effects, scour, etc.) must be factored into the design. In the southern United States, lightning is a frequent occurrence, and even a nearby strike can damage electronic components.

Typical wave conditions range from near-calm to steep, locally generated wind waves up to 10 ft in height, with periods in the range of 4-9 sec, to storm-generated swell with periods in the range of 10-12 sec. Waves shorter than 4 sec were judged to have no significant impacts on the mounds, and waves longer than 12 sec are rare in the Gulf. During a hurricane, depth-limited or even breaking waves (i.e., on the order of 16 ft in height) may approach the active berm. The resulting conditions on the active berm would be extremely violent.

While wave conditions represent a hazard on occasion, it was recognized that trawling activity represented the highest risk to any instrumentation in this region. Fishing trawlers drag large nets across the seafloor, snagging or removing unprotected instruments. Buoys marking a site have not proven an adequate defense, as they are routinely overrun, particularly when newly placed in a fishing area. Massive structural defenses interfere with the currents to be measured, and potentially with the response of the mound itself.

Logistic Factors

The fixed structure nearest to the study site is an offshore gas well, SHNM 113 SL 531 No. 1, owned by Shell Oil Co. It is approximately 1,000 ft southeast of the southern end of the active berm, and just east of Area 1. Plans were developed to use the well as a convenient platform for mounting system components, and a fixed base for positioning purposes.

Commercial vessels were available in Mobile that could be adapted for deploying equipment, but the specialized equipment and expertise required for placing heavy gear in unprotected waters usually incur high mobilization costs. One of the most valuable assets available to the project was the U.S. Coast Guard cutter "White Pine," a seagoing buoy tender, and her able crew, from the U.S. Coast Guard District, Mobile. Support by the vessel and the facilities and experienced personnel of the Coast Guard resulted in considerable savings to the Government and a substantial contribution to the success of the effort.

Sensors

PMAB has found that bottom-mounted pressure transducers are reliable, rugged sensors that can provide relative water levels and non-directional wave conditions when used singularly, as well as directional wave information when used in arrays. Another method of obtaining directional wave parameters is by measuring pressure P , and the two horizontal components of the orbital velocity (u, v) with a current meter - the PUV gauge. Analysis of the current meter signal also provides instantaneous and mean current data. The trade-off is a sensor that is less robust and more expensive than a pressure transducer. An electromagnetic current meter is usually used since it has no moving parts to foul or clog, though it does require more frequent servicing than a pressure transducer for removal of biofouling. However, the depth-attenuated pressure and orbital-motion response of surface waves limits bottom-mounted PUV gauges to shallower depths for higher frequency waves. While suitable for the 10- to 15-ft depths of Area 4 and the 20- to 30-ft depths of Area 1, they were not judged adequate to resolve waves shorter than 6-8 sec in the depths near the stable berm.

Another approach to measuring directional waves is the pitch-roll-heave surface-following buoy. It is unaffected by pressure attenuation, but is not as well-suited for shallow water, since it violates the surface-following assumption in steep waves, and short moorings affect the motion in nonlinear ways. One of the first such systems developed by the National Data Buoy Center (NDBC) was available for deployment in August, 1987. This buoy measures wind, atmospheric pressure, and air and sea temperature, as well as waves, but not water depth. Water depths of 40-50 ft made the NDBC buoy a logical choice in Areas 2 and 3.

Obtaining current measurements from a buoy in these depths is complicated by the motions of the buoy and mooring. Separate bottom-mounted current meters in addition to the buoys were not within the budget. However, orbital velocities can be deduced, using linear wave theory, from the directional wave data. Tidal elevations and tide-induced mean currents do not vary significantly over distances on the order of miles (as long as the bathymetry changes are gradual), so these could be adequately represented at Areas 2 and 3 by the measurements at Area 1. On the other hand, currents can be significantly different on the top of the active berm because the steep slopes will directly affect the currents by deflecting incident flow, and its location in a potential breaker zone can result in setup or set-down that will affect the local hydraulic gradient. This was another consideration in selecting a PUV gauge for Area 4.

Like any instrument, a wave gauge has a range of values over which it can be considered "accurate," within limits of uncertainty. While the individual sensors can be calibrated in a laboratory, when they are combined to make a wave gauge, the limits, thresholds, and maxima vary with site, gauge placement and mounting, analysis technique, and even wave conditions. The reduced wave parameters are not measured directly by a PUV gauge, but are statistically derived estimates based on wave theories relating water surface elevation to indirect measurements of pressure and velocity (which, in turn, are derived from a magnetically induced voltage). The time series is transformed to the frequency domain, and a "peak" is selected from the spectrum to represent the period. If the spectrum is broad, or there are two or more modes of near equal energy, minute variations in signal strength can result in widely differing values for "the" peak.

Another consideration is that the spatial variability of these reduced parameters (wave height, velocity, etc.) over horizontal distances on the scale of meters may be large compared to the uncertainty in measurement. Meanwhile, the ability to position the gauge horizontally, and thus specify the measurement point in space, is no better than ± 10 m. Thus, the question of accuracy of a field measurement is less meaningful than the applicability of the measurement over the spatial scale of interest. A reasonable estimate for the "validity" of the various measurements, given the size of the areas they are meant to represent, is: for significant wave heights, ± 0.1 m; peak wave period, ± 0.5 sec; spectral wave direction, ± 5 deg; mean current direction, ± 5 deg; and mean current magnitude, ± 0.1 m/sec, all over the range of significant wave heights from 0.1 m to breaking. Caution and in-depth investigation into the complete time series and resultant spectra are advised before utilizing the reduced parameters beyond these estimated accuracies. Peak period and direction, in particular, are subject to large differences resulting from minor variations in the energy distribution under certain conditions (see Chapter 6 for discussion). These are not uncertainties in measurement, but rather artifacts of the definitions of the terms.

Peak wave directions associated with significant wave heights below 0.1 m should be used with particular caution owing to the small amplitudes of the individual spectral components. Conversely, under the most severe wave conditions, such as those associated with a nearby hurricane, Area 4, in particular, will become a surf zone. As the waves begin to break, the assumptions of linear wave theory relating surface elevation to sea-surface slope, pressure, or orbital velocities become less appropriate. The sensor will be in a regime of extreme turbulence, with high concentrations of suspended sediment and entrained air. Without the presence of distinct air-water and water-sand interfaces, the ability to even define such parameters as wave height or water depth, let alone measure them, deteriorates.

Schedule

The construction schedule of the two berms drove the study schedule. The active berm was completed between January and February 1987. Construction of the stable berm was begun in February 1988. It was desired to begin collecting the incident wave conditions for both mounds prior to their construction. Installation of the CERC-designed real-time system was originally planned for 1988, but was delayed by construction activities on the gas well. The well was scheduled for conversion from a simple raised wellhead to a production platform between winter 1988 and spring 1989. It was not practical to install equipment on the platform prior to construction activities. In the interim, and to accommodate the relatively short lead time (funds were made available at beginning of fiscal year (BOFY) 87) commercially available, self-recording gauges were selected for initial monitoring in Area 1 (see "Data Capture Plan" in Chapter 4).

Power

Power for collecting and transmitting data had to be provided using storage batteries, either within each gauge or at a central location. The NDBC buoys, having adequate displacement to carry the weight, are powered by internal primary and secondary storage batteries. Self-recording gauges usually carry internal batteries that are matched in duration to the memory limitations of the internal data logger. If telemetry is used, more frequent or longer sampling is possible, but at the expense of more power. If a structure is available to mount solar cells, a solar power system can reduce the size of the storage batteries and extend intervals between servicing.

4 Data Management

Data Capture Plan

Two approaches are available to capture sensor signals for further analysis, and both were used in this study. Internal recording of the data in the instrument, with periodic retrieval, is usually less expensive for initial installation. Since recovery is usually accomplished by divers, cost benefits are lost as the monitoring period increases. This approach was considered adequate initially to reduce lead time and costs as compared to a real-time data telemetry system. However, repeated gauge loss and associated data gaps proved the necessity of a custom-designed measuring system (see Chapter 6, "Results"). Telemetry to shore for storage provides more secure data return and near-real-time availability of the data. Initial costs are higher, and more lead time is required for fabrication and installation, but overall costs can be less for long-term deployments.

Commercially available, self-contained Sea Data 635-12 PUV gauges (Figure 3) were used in Area 1. Raw signals from the Sea Data gauges were recorded internally on magnetic tape. When the instrument was retrieved, the tape was removed and returned to CERC for downloading to PMAB's VAX 11-750 computer using a Sea Data tape reader. Additional analysis can be scheduled when convenient.

At this site, practical telemetry options are either hard-wired, which involves laying a cable to shore, or radio telemetry, which requires a surface-piercing antenna. Radio is the obvious choice for the buoys. NDBC utilizes the Geostationary Orbiting Earth Satellite (GOES)

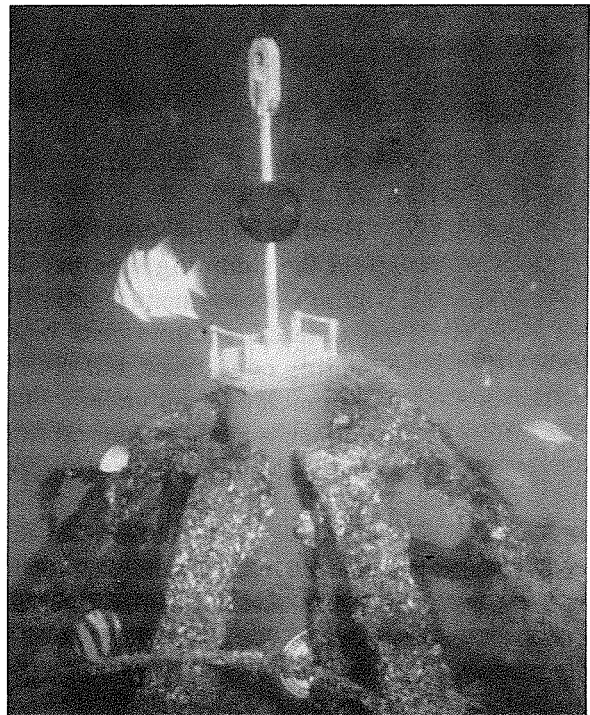

Figure 3. Self-recording gauge in mount

network to transmit data hourly to NDBC headquarters at Stennis Space Center, MS, for quality control and reporting. Monthly files of analyzed, edited data are delivered to CERC on 9-track magnetic tape at the end of the month following collection.

For the real-time PUV gauges, the distance made cabling directly to shore impractical, but the nearby gas well provided a convenient site for a relay station. Signals were sent via cable from the measurement site to the platform. Various radio bands and networks are available to transmit data either directly to CERC, or to another relay station on shore, and from there to CERC via land telephone lines. However, the availability of cellular phone service in the Mobile area eliminated the need for a separate radio transceiver link.

The disadvantage to any telemetry link is the risk of losing a transmission for various reasons. To ensure that transmission malfunctions and errors will not necessarily result in lost data, a backup memory can be provided either in the instrument or the intermediate relay station to store data in the event communications are lost. For this study a three-day buffer at the relay station was considered adequate to permit reestablishment of the phone link without loss of data. Once filed on the PMAB VAX, data could be analyzed when convenient.

While a continuous record is identified as a need in Chapter 2, true continuous sampling at each site is not practical or desirable. A realistic sampling scheme was selected to limit the data collected and analyzed while providing adequate temporal resolution of the conditions. A sampling rate of 1 Hz is adequate to resolve waves with periods as short as 4 sec. To obtain an adequate population (on the order of 100 waves) of the longer, 10- to 12-sec waves of interest, the sample length must be on the order of 1,000 sec. (The actual sample length used is 1,024 sec to simplify spectral analysis.) Longer lengths are not necessarily desirable, since they may violate the assumption of stationarity of conditions.

For the internal recording gauges, battery and memory limitations also affect the sampling scheme. If measurements are made at 6-hr intervals, a 3-month deployment is possible before the tape is filled. If the data are telemetered, sampling can be done at shorter intervals to define rapidly changing conditions, but at the expense of collecting and analyzing more data, much of it redundant. The most efficient solution is a remotely programmable sample interval that permits a 6-hr interval for routine conditions, and more frequent sampling during storms.

Data Quality Control

PMAB has developed extensive procedures for data quality control and assurance which are performed on all measured data. Before performing analysis, initial data quality is determined by inspecting the sensor's

signals. Plots of pressure and velocity time series are inspected daily to determine if gauges have malfunctioned. Problems such as plugged pressure ports, biofouled current meter probes, power failures, etc. are easily detected by PMAB personnel. This practice ensures that malfunctioning systems are identified so they can be replaced and quality data can be collected whenever possible.

Pressure data are inspected for electronic noise, which usually appears as isolated large data "spikes" in the measured time series. Failure to eliminate spikes contaminates higher frequency bands with unrealistic energy. Automated routines have been developed to check for the number and amplitude of spikes. Data values larger than those that are physically possible are corrected using linear interpolation if spikes do not occur in sequence; otherwise, the erroneous values are replaced with the record mean. If 10 percent of the total number of samples in a wave record are determined to be spikes, analysis of that record is discontinued.

Pressure time series are examined for stationarity prior to spectral analysis. Data are adjusted if linear trends, resulting from rising or falling tides, are identified. Records with higher-order trends are rejected.

Once data are spectrally analyzed (see below), results are examined to determine if they are realistic. Significant wave heights, peak periods, and peak directions are compared to available data from other sources for correlation. Directional spectra of suspect records are examined to determine if physical explanations are possible for differences from expected results.

Spectral Analysis

PMAB has developed algorithms for estimating the directional energy distribution in the frequency domain (the two-dimensional spectrum) using time series from pressure arrays or PUV gauges. A sea surface spectrum, $S(f, \theta)$, may be obtained from either a pressure spectrum or a velocity spectrum by using linear wave theory. The procedure is based on the method for single location measurements, first used by Longuet-Higgins, Cartwright, and Smith (1963) for data obtained from a pitch-roll-heave buoy. Details of theories for estimating a directional sea surface spectrum can be found elsewhere (e.g., Phillips (1977) and Kinsman (1965)).

The theories are based upon the following expression for $S(f, \theta)$ using a cross power spectrum, $\Phi_{mn} = C_{mn} - iQ_{mn}$, between pairs of sea surface fluctuations at m and n .

$$C_{mn}(f) - iQ_{mn}(f) = \int e^{ikx} S(f, \theta) d\theta \quad (1)$$

where k is the wave number vector, and x_{mn} is the difference between two position vectors x_m and x_n . Using the cross spectrum between any pairs of P , u , and v , the above expression becomes

$$C_{mn}(f) - i Q_{mn}(f) = \int H_m H_n^* S(f, \theta) d\theta \quad (2)$$

where H_m and H_n^* are linear transfer functions with * denoting a complex conjugate. For convenience, $S(f, \theta)$ is usually written as

$$S(f, \theta) = S(f) D(f, \theta) \quad (3)$$

where $D(f, \theta)$ is a directional spreading function, and $S(f)$ is the non-directional (one-dimensional) sea surface spectrum: i.e.,

$$\int S(f, \theta) d\theta = S(f) \quad (4)$$

The directional spreading function, $D(f, \theta)$, is then written as a Fourier Series with the cross power spectrum.

A fast Fourier transform (FFT) routine is used to compute the power and cross-power spectra from the measured time series. A 10-percent cosine bell window is applied to the beginning and end of each 1,024-sec time series prior to FFT analysis to reduce the undesirable effects of side lobes and spectral leakage in the transformation into frequency space. Spectra are smoothed by segmenting the spectral information, with each segment containing eight consecutive frequency lines, and computing the ensemble averages for each segment. The resulting frequency resolution, when the sample length is 1,024 sec, is 0.0078 Hz.

The energy-based significant wave height H_{m0} , is estimated using the formula

$$H_{m0} = 4 \sqrt{\int S(f) df} \quad (5)$$

where $S(f)$ is band-pass filtered with a high frequency cutoff of approximately 0.33 Hz to reduce artificial effects of high-frequency signals (electronic noise). A peak wave period T_p , is defined as the inverse of the peak frequency f_p , at which $S(f)$ has its maximum value.

PMAB routinely displays directional spectral information in the form shown in Plate 1. For each frequency line reported, energy and peak direction are calculated with the frequency spread over sixteen 22.5-deg directional "bins" using the method described by Longuet-Higgins, Cartwright, and Smith (1963).

A convenient way to present the directional information, instead of presenting $D(f, \theta)$ over the entire frequency range, is to use the mean direction, $\bar{\theta}$, defined as

$$\bar{\theta} = \tan^{-1} (b_1/a_1) \quad (6)$$

where a_1 and b_1 are the x- and y-component averages of $D(\theta)$ (using a Cartesian coordinate system, (x,y)); i.e.,

$$a_1 = \int D(\theta) \cos(\theta) d\theta \quad \text{and} \quad b_1 = \int D(\theta) \sin(\theta) d\theta \quad (7)$$

Thus, $\bar{\theta}$ may be interpreted as the direction of the average vector (a_1, b_1) for each frequency. The peak direction reported on Plate 1 is the mean direction for the peak frequency, f_p .

Current Parameters

The following current statistics were calculated from the instantaneous u and v velocities from each individual 1,024-sec record:

- a. Average current, or the mean instantaneous water particle velocity. Instantaneous velocity is defined for each 1-sec sample as the square root of the sum of the u velocity squared and the v velocity squared. The computed instantaneous water particle velocities are all positive and are averaged to compute this value. Hence, direction changes are not reflected in the "average current" and it is not a measure of net water motion at the gauge.
- b. Maximum current, defined as the magnitude of the largest instantaneous water particle velocity for any 1-sec sample in the record. This may be an extremely large value.
- c. Median current, or the median instantaneous water particle velocity.
- d. Standard deviation of instantaneous water particle velocities defined in the usual sense.
- e. U mean velocity, the statistic calculated by summing all u velocities (positive and negative) over a single record divided by the number of velocities summed.
- f. V mean velocity, the statistic calculated by summing all v velocities (positive and negative) over a single record divided by the number of velocities summed.

- g. Current direction, calculated using mean U and V velocity vectors. This statistic is the direction in degrees toward which the net current is flowing.**

5 System Design

General

Hardware design for the internal recording gauges in Area 1 was limited to mounting options. The various configurations used to keep the gauges on station are discussed below. The CERC-designed system used a central power/telemetry station mounted on the gas well, with two remote PUV gauges in low-profile mounts connected by cable to the central station. Solar cells and storage batteries powered the central station and both remote gauges.

Actual gauge locations within each area are provided in Table 1 and illustrated in Figure 2.¹ Multiple sites within an area are numbered chronologically by deployment; for example, Sites 1.1 through 1.5. When Site 1.1 was originally selected, the location and dimensions of the stable berm had not been specified. Once delineated, the stable berm's boundaries encroached into the original Area 1. Subsequent deployments (1.1 - 1.5) were moved northward into a reduced Area 1. Two sites were selected in Area 4: Site 4.1 was at the shallowest portion of the active berm. Site 4.2 was placed on a smaller mound a few hundred feet southeast of the long Sand Island Berm. Though outside of the original Area 4, it provided data on conditions at another location of similar depth to better define the spatial variability of synoptic measurements.

Internal Recording Gauges

The PUV gauge selected for Area 1 had to be securely fixed to the bottom and protected from damage by trawl nets. A lighted marker buoy was desirable for protection and to aid in recovery. The buoy mooring weight provided a stable, fixed mount for the instrument. Five different designs and deployment sites were tried, with varying success, to survive the

¹ Conversion from this siting nomenclature to that used in previous reports is provided in Appendix D.

repeated impacts by trawlers. A brief description of the different designs and their performance is provided in this section.

The first two designs (Sites 1.1 and 1.2) utilized standard 6-ft-diam, 6,000-lb displacement Coast Guard navigation buoys (Figure 4). The gauge was mounted vertically to the 8,500-lb concrete mooring weight with the current sensor extending 2 ft above the top of the rectangular weight. A taut moor at all stages of the tide was necessary to avoid fouling the mooring line in the sensor. A standard chain mooring would have either resulted in the buoy "walking" (lifting and dragging) the weight under high wave and tide conditions, or the use of a mooring weight beyond the lifting capacity of the *White Pine*. For the first buoy an elastic mooring was made from a bundle of six 1-in.-diam rubber cords. This cord is typically used to moor Waverider-brand wave-measuring buoys and was readily available.

The first gauge site, 1.1, was selected on the advice of local fishermen and the Coast Guard's recommendation for the optimum operating depth for that particular buoy (U.S. Department of Coast Guard Transportation 1975). After 6 months, the buoy, mount, and gauge were lost and never recovered. The second buoy had a similar design, but a "snubber" of 1-in.-diam nylon line, longer than the elastic tether, was placed in the mooring as a safety link in the event the elastic cords failed. It was placed in shallower water within the redefined Area 1 [Site 1.2(I)]. This buoy was dragged 1/2 mile off station, but was recovered [Site 1.2(R)]. The instrument was destroyed.

The design for Site 1.3 attempted to improve reliability by increasing the size of the mooring weight and tether and decreasing the displacement of the buoy (Figure 5). The Coast Guard provided an experimental foam buoy that had external dimensions similar to the standard buoy, but with only one tenth the mass. It featured a smooth exterior with no convenient attachment points, to discourage vessels from tying up to it. A 3-in.-diam rubber cord, with a breaking strength near 10,000 lb was used for the elastic tether. The mooring weight was a 12,000-lb concrete block, the largest the *White Pine* could manage. Two Sea Data gauges were installed for redundancy, and an acoustic beacon was supplied to aid in recovery. The buoy was reported missing early in November. The weight and undamaged instruments were later found on station, but overturned; the tether had parted from what appeared to be a knife cut. A local fisherman reported seeing three large (~100-ft length) trawlers tied bow to stern to each other, with the lead vessel tied to the buoy. They were riding out a choppy sea using the instrument mooring as an anchor. The buoy was sighted several months later 10 miles south of Salinas, Puerto Rico. Examination of the record showed the mount was overturned near dawn of 3 November.

The next approach assumed that warning buoys placed around the instrument would give vessels notice that they were entering a restricted area before encountering the instrument. Steel spheres, 3 ft in diameter,

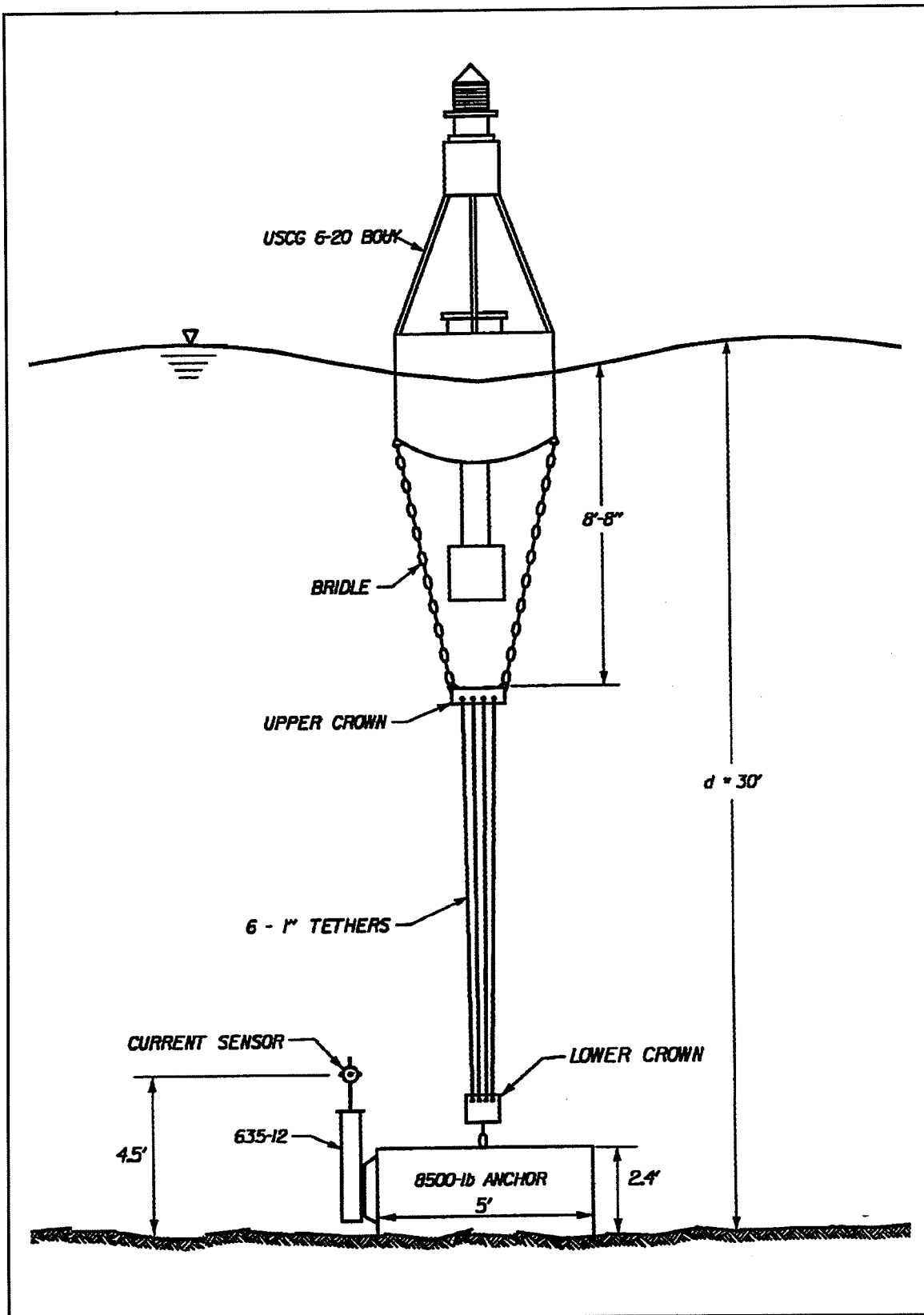

Figure 4. Standard USCG buoy with elastic mooring - Site 1.1

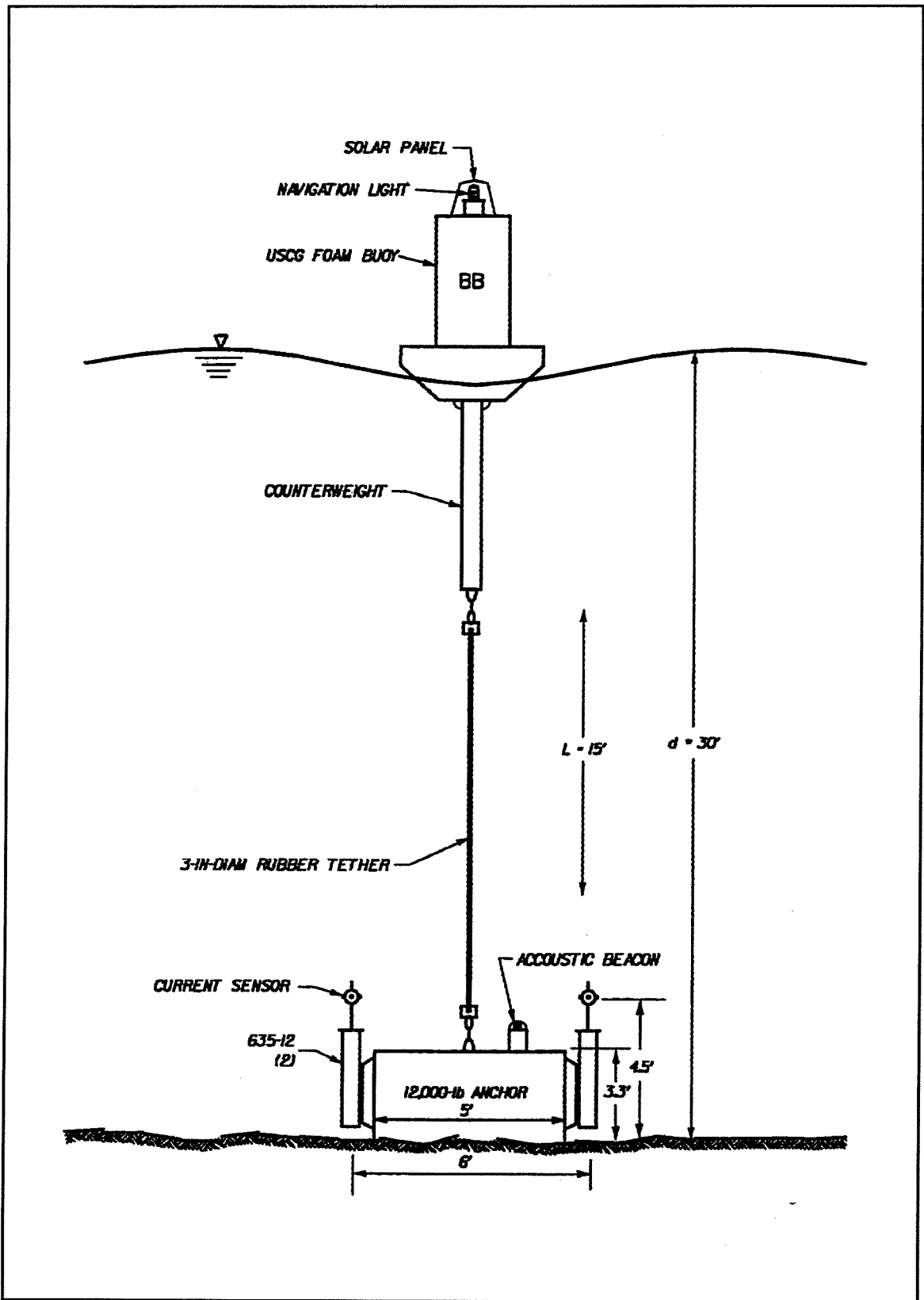

Figure 5. Foam buoy with elastic mooring - Site 1.3

were moored on either side of the instrument. The mount was identical to that used at Site 1.3, but it was marked with a sub-surface buoy to preclude attachment. This arrangement lasted through the winter of 1987/88, but was lost in early April 1988. The weight and instruments were recovered 7 months later 1.5 miles to the south [site 1.4(R)]. Data tapes from the gauges were salvaged, but both gauges were damaged beyond repair.

Retreat to a more defensible position proved the only effective strategy for this design of gauge. Site 1.5 was selected about 100 ft south of the gas well. It was outside of the original Area 1, but offered the protection of a more robust structure. Two gauges were mounted on a steel frame pinned to the bottom with water-jetted, 2-in.-diam pipe piles. No buoy was used to mark the site since buoys appeared to serve as targets rather than warnings. The compromise in the location is considered acceptable, as the instrument at this site did not experience any mishaps.

NDBC Buoys

Design and operation of the NDBC buoys are described in Steele et al. (1990). The platform is a 3-m-diam surface-following buoy (Figure 6) using a chain moored to a concrete weight. The first (NDBC station 42015) was deployed on 22 April 1987 [Site 2] in 55 ft of water. This site, as opposed to one closer to the stable berm, was requested by the Coast Guard to avoid potential confusion with channel buoys. It operated in a test

mode for several months before data were made available beginning in August 1987. The second buoy (NDBC station 42016) was deployed in April 1988 in 45 ft of water [Site 3].



Figure 6. Standard NDBC 3-m buoy

Time series signals from the NDBC buoys are processed onboard into one-dimensional energy spectra and Fourier coefficients of the directional distribution. The reduced spectral products are transmitted via GOES network to NDBC at Stennis Space Center, MS, for editing and quality control. NDBC does not provide a complete two-dimensional spectrum for each measurement as a standard product. The customer must select and apply a spreading model to distribute the energy in direction and frequency using the coefficients provided. Monthly reports were sent on 9-track tape to CERC for the additional processing previously described.

CERC Real-Time System

General

The CERC system was designed to achieve a better data return rate than was experienced by the internal recording gauges. It features: real-time telemetry to monitor system performance and ensure capture of all data measured prior to gauge failure; an onsite memory buffer to hold and retransmit data in case of telemetry failures; microprocessor-controlled data transfer protocols and solid state storage devices to ensure error-free signals; and a compact, trawler-resistant mount. This approach was chosen because of previous problems with data gaps due to failures with internal recording gauges and experience which indicated minimal downtime for similar real-time systems operated at other locations across the country. By using a real-time system it was possible to determine the data quality daily, find system failures within hours of the failure, and make repairs within days.

The real-time system consists of: two PUV gauges consisting of underwater Serial Asynchronous Units (SAU), with internal pressure gauges and external electromagnetic current meters, and a Remote Transmitting Unit (RTU) with a Solar Power System mounted on the gas well. Underwater cables connect the SAU's to the RTU. Details on sensor design, including specifications, are found in Appendix A.

An SAU is housed in a 6-in.-diam cylindrical Lexan underwater pressure housing (Figure 7). It consists of a Digiquartz pressure sensor to measure the pressure time series and standard bus (STD BUS) electronics to convert the analog signals from the current meter and the frequency output from the pressure sensor to a single serial output. A 50-ft underwater polyurethane-coated cable connects an electromagnetic current meter to the SAU. The two SAU's are connected to the RTU by approximately 5,100 ft (Site 4.1) and 900 ft (Site 4.2) of 1/2-in.-diam, seven-conductor, double-armored, well-logging cable. The cable was selected for its strength (working load approximately 12,000 lb) and its density (specific gravity approximately 5.0). This dense cable will self-bury in a non-cohesive seafloor to minimize the risk of snagging by trawl nets or anchors.

The RTU mounted on the gas well consists of STD BUS electronics for processing, storing, and transfer of data; power converters; cellular phone for retrieving the data; and lighting protection devices. The RTU was mounted in a weatherproof, stainless steel enclosure. The use of an RTU mounted on the gas well allowed connecting two SAU's to one RTU and simplified maintenance since divers would not be needed for repairs to the RTU. Two solar power systems were used to produce power for the system.

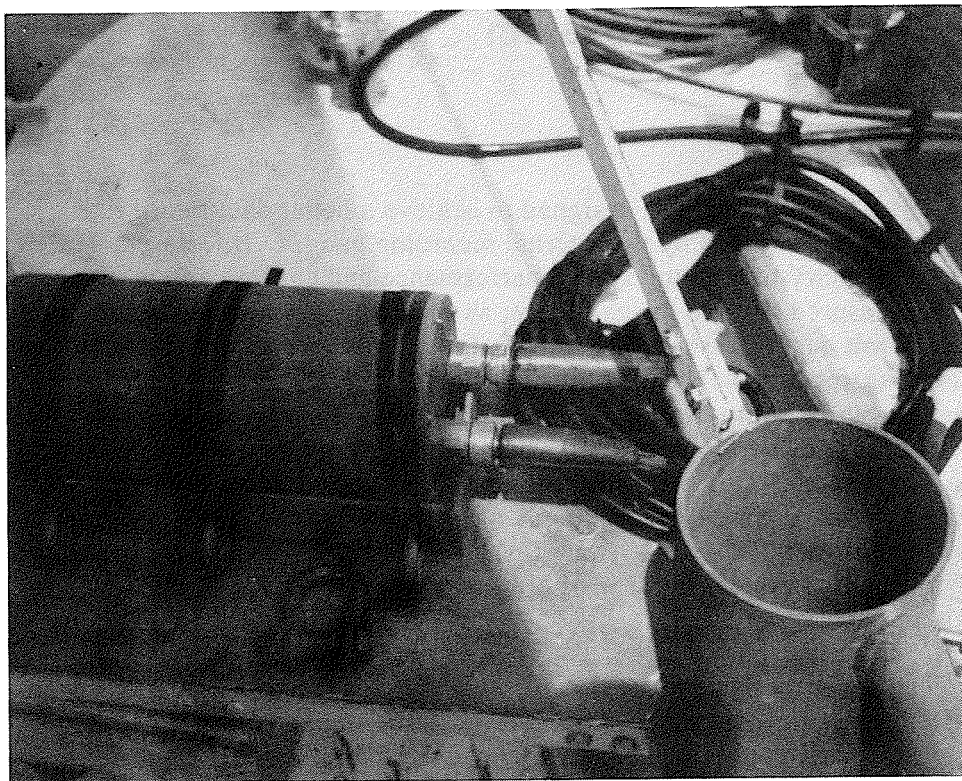

Figure 7. CERC-designed SAU on mount

Signal processing

An overall system signal block diagram is shown in Figure 8. The analog output of ± 3 volts DC (VDC) from the current meter is fed to the SAU through an 8-conductor polyurethane-coated cable. The pressure gauge is connected to a CERC pressure interface card (PIC). This card converts the frequency signal from the pressure gauge to an analog output of ± 5 VDC. The two analog signals from the current meter and the single analog signal from the PIC are fed into an A-D converter card. The A-D card is a CMOS 12-bit, analog-to-digital converter designed for the STD BUS. It combines the three signals and converts them from analog signals to a multiplexed digital signal. The digital signal is then fed to the CPU card. The CPU card is a compact, multi-function, single-board computer. A CERC-programmed read only memory (ROM) is used to control the CPU, sample the data at 5 Hz, and convert the output to a single serial output. The PIC, CPU, and A-D converter cards are mounted in an STD BUS card cage inside the SAU. The serial output from the CPU card is hard-wired to the input/output connector of the SAU, and protected from lightning by 6-VDC transorbs.

The serial signals from the two SAUs are connected to the RTU by separate double-armored cables. The signals are sent through the cables, to connectors, and then through a terminal strip in the RTU, which includes lightning protection devices. The serial signals are then connected to a

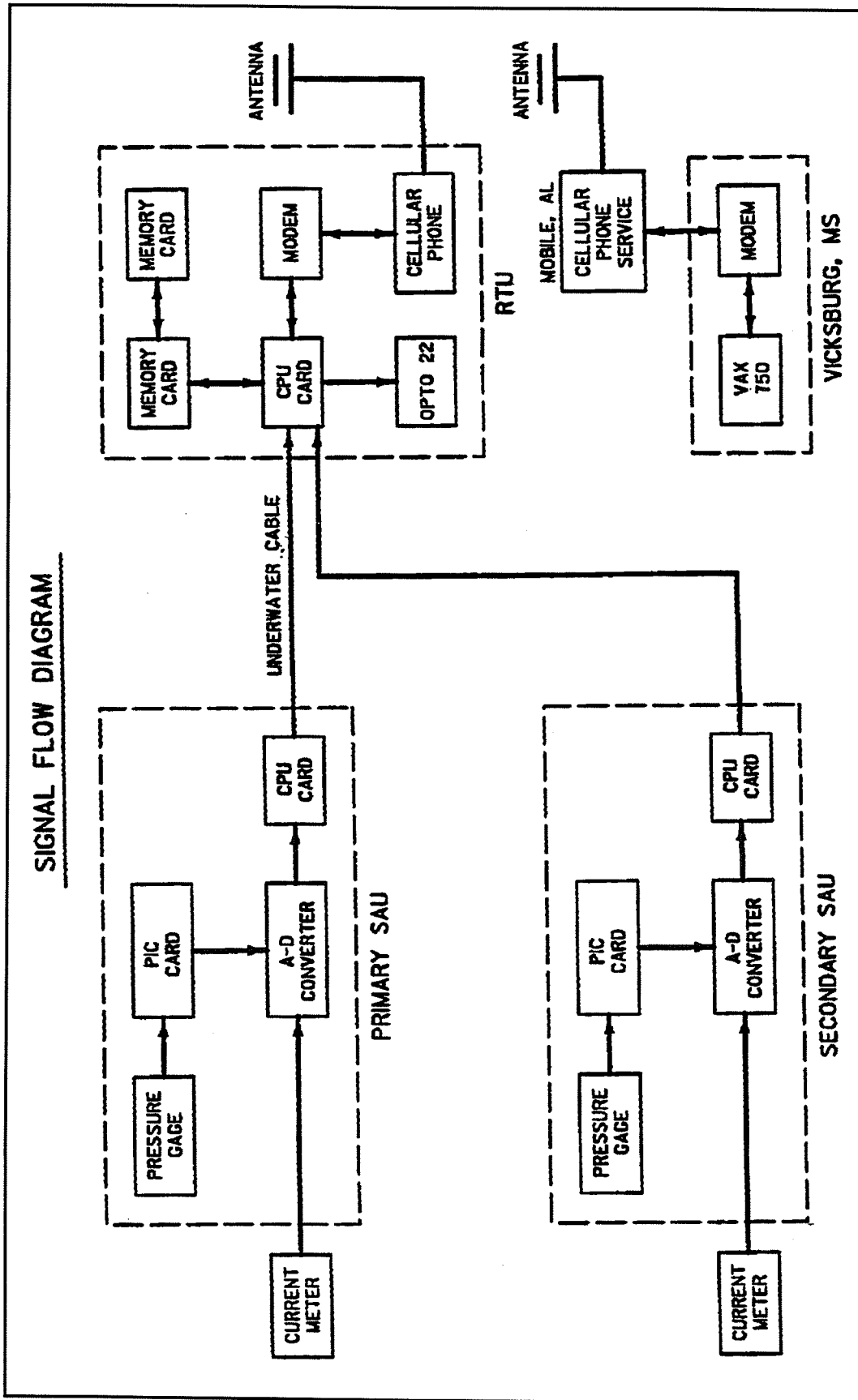

Figure 8. Signal processing flowchart for CERC-designed system

CPU card. This CPU card controls the operation of the system; turns the SAUs on for 17 min every 2 hr when both SAUs are in operation, and every hour when only one is operational; collects these data at a 1-Hz rate; and stores the 17-min data record in two memory cards. The memory card is STD BUS compatible and designed for low-power applications. By using two memory cards, 3 days of data can be stored. The CPU card outputs a signal to a modem, which is hardwired to a cellular phone. The cellular phone transmits its signal through a directional antenna mounted outside the RTU on the platform.

Telemetry

The CERC VAX 11-750 automatically calls the RTU twice per day and collects every fourth hour of data files. If the cellular phone does not answer, the VAX 11-750 redials every 2 min until it receives three failures. If a major storm or other event occurs, the program can be manually adjusted to pull files every 2 hr when both SAU's are operational, and every hour with one SAU operating. The VAX 11-750 calls through the local phone system to the Contell Cellular phone system in Mobile, AL, by hard-wire phone line, and from Contell Cellular to the platform by cellular transmission.

Power supply

An overall system power block diagram is shown in Figure 9. The system power is divided into a 24-V electronics subsystem, and a 12-V communication subsystem. Both are powered by solar photo-voltaic panels mounted on the platform above the RTU (Figure 10). The solar panels provide about 150 percent of the daily power requirement on a sunny day, while the rechargeable batteries, mounted under the RTU, have adequate reserve power for 2 weeks of routine operation.

The electronic subsystem is powered by a 24-V, 10-amp-hr solar collector array. A 100-amp-hr lead-acid battery pack provides supplementary power during cloudy and dark conditions. The 24-V power enters the RTU through a connector and is protected from lightning by a surge protector. Power is split at this point. One part goes to the power card where it is converted from 24-V to 5-V and ± 12 -V to supply the power needed for the STD BUS electronics. The 24-V also goes to the Opto-22 power switcher card, which is controlled by the CPU card, to supply power to both SAU's. The switcher turns on the power to the SAU's for 17 min when data are collected and stored, reducing power by one third compared to full-time powering of the SAU's.

From the power switcher, the power is split and goes through a fuse to the connector that supplies power to SAU 4.2 through the double-armor cable. The 24-V power from the Opto-22 switcher also goes to a system power card, which converts the voltage from 24-V to 60-V using a DC-DC

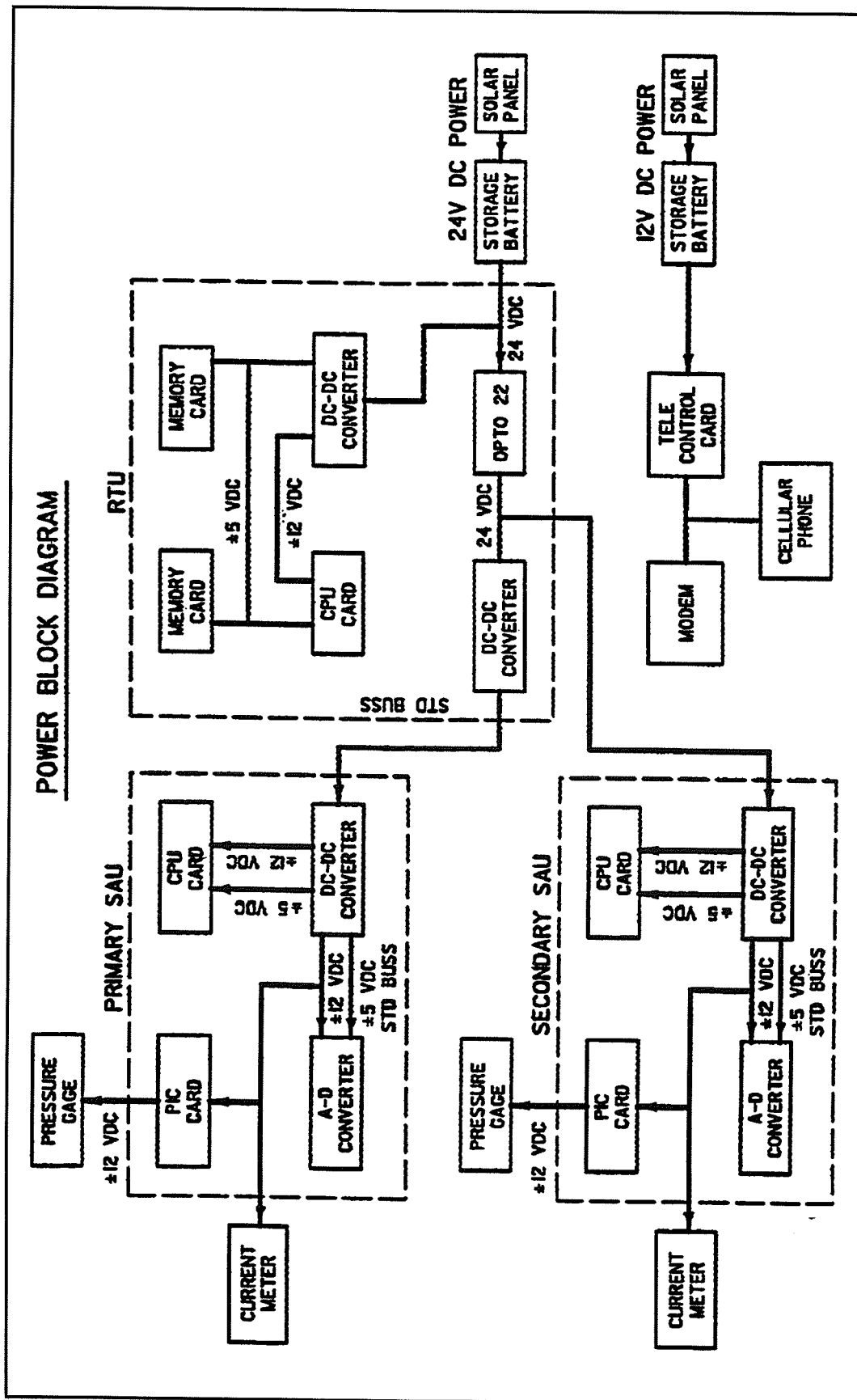

Figure 9. Power distribution flowchart for CERC-designed system

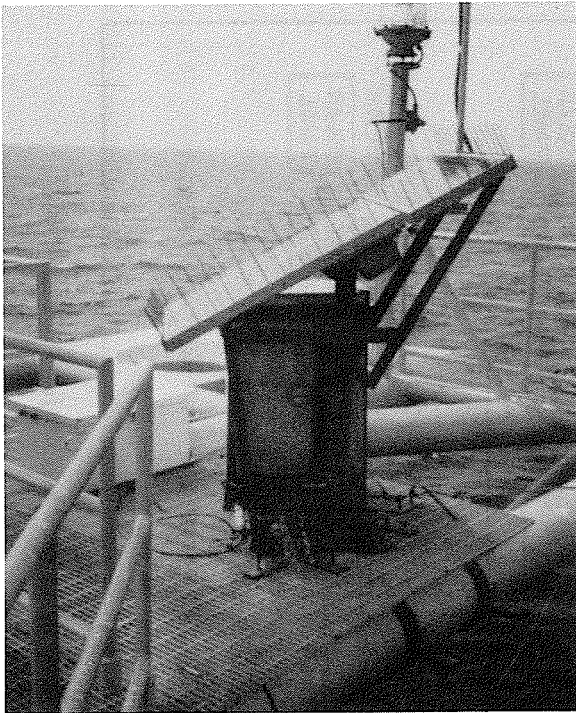

Figure 10. RTU and solar power system on gas well

converter. The 60-V power is sent through a fuse to SAU 4.1. The higher voltage for SAU 4.1 is required because of the voltage loss through the longer cable.

A 12-V, 8-amp-hr solar power system supplies power to the cellular phone through a telephone control card, which alternates between power on, for 2 min; and power off, for 4 min. This reduces the power requirement by 66 percent and allows for the use of a smaller, lower amp-hr solar power system. When data are being transmitted, the telephone control card keeps the power on for 2 min after data transmission has stopped. The power then goes to the modem and the cellular telephone. Overall power requirements are shown in Table 2.

Each SAU receives its power from the RTU. The power comes through the connector on the SAU to the DC-DC converter card in the STD BUS rack. This card receives the voltage (60 V for SAU 4.2 and 24 V for SAU 4.2) and converts it to 5 V and ± 12 V to operate the STD BUS cards. The ± 12 -V value also supplies the operating voltage to the current meter through the polyurethane-coated cable. Pressure gauge power is supplied from the +12-VDC output of the PIC card.

Mounts

Each SAU and current meter is mounted in a trawler-resistant pod (Figure 11), which is installed by divers. Each pod is secured to the bottom with three 1-in.-diam galvanized pipes jettied 10 ft into the bottom and clamped to the pod. The pod design causes trawl nets to move over the pod and down the other side with little resistance. These pods have proven effective in resisting trawler damage in laboratory tests and field operations. The pod may still be snagged by the door portion of the trawl gear or by anchors; but, when this happens, the pipes that hold the pod to the bottom generally prevent the pod from being moved.

The mount, in protecting the current sensor from damage, invariably "protects" the sensor, to some extent, from the currents. To minimize the unavoidable effects of the mount on the flow, the frame is made with small structural members (1-1/2 in. by 3/8 in.) no closer than 18 in. to the current meter sensor. Turbulence induced by vortices shedding from the

**Table 2
Power Budget**

24-V DC Solar Power System			
SAU			
Item	Power Draw		
CPU Card	1.80 watts		
A-D Conv	1.21 watts		
PIC Card	0.41 watts		
Pressure Gauge	0.30 watts		
Current Meter	1.20 watts		
DC/DC Conv	1.48 watts		
Total	6.40 watts		
RTU			
CPU Card	1.80 watts		
Memory Cards	2.60 watts		
DC/DC Conv	1.30 watts		
Total	5.70 watts		
SAU #1	6.40 watts	57.9 volts DC	0.11 amps
SAU #2	6.40 watts	22.0 volts DC	0.29 amps
RTU	5.70 watts	24.0 volts DC	0.24 amps
Total			0.64 amps
Item	Current	Operating Hours	AH/day
SAU #1	0.11 amps	4	0.44
SAU #2	0.29 amps	4	1.16
RTU	0.24 amps	24	5.76
Total			7.36
Solar Location Efficiency 1.15 8.97 AH/Day			
12-V DC Solar Power System			
Item	Current Draw	Volts DC	
Cellular Phone Operating	1.95 amps	12 Volts DC	
Stand-by	0.40 amps	12 Volts DC	
Modem	0.05 amps	12 Volts DC	
Power Switcher Operating	0.05 amps	12 Volts DC	
Item	Current	Operating Hours	AH/day
Operating	0.05 amps	24	1.20 (power switcher)
Stand-by	0.45 amps	7.0	3.15 (phone, modem)
Operating	2.00 amps	1.0	2.00 (phone, modem)
Total			6.35
Solar Location Efficiency 1.15 7.30 AH/Day			

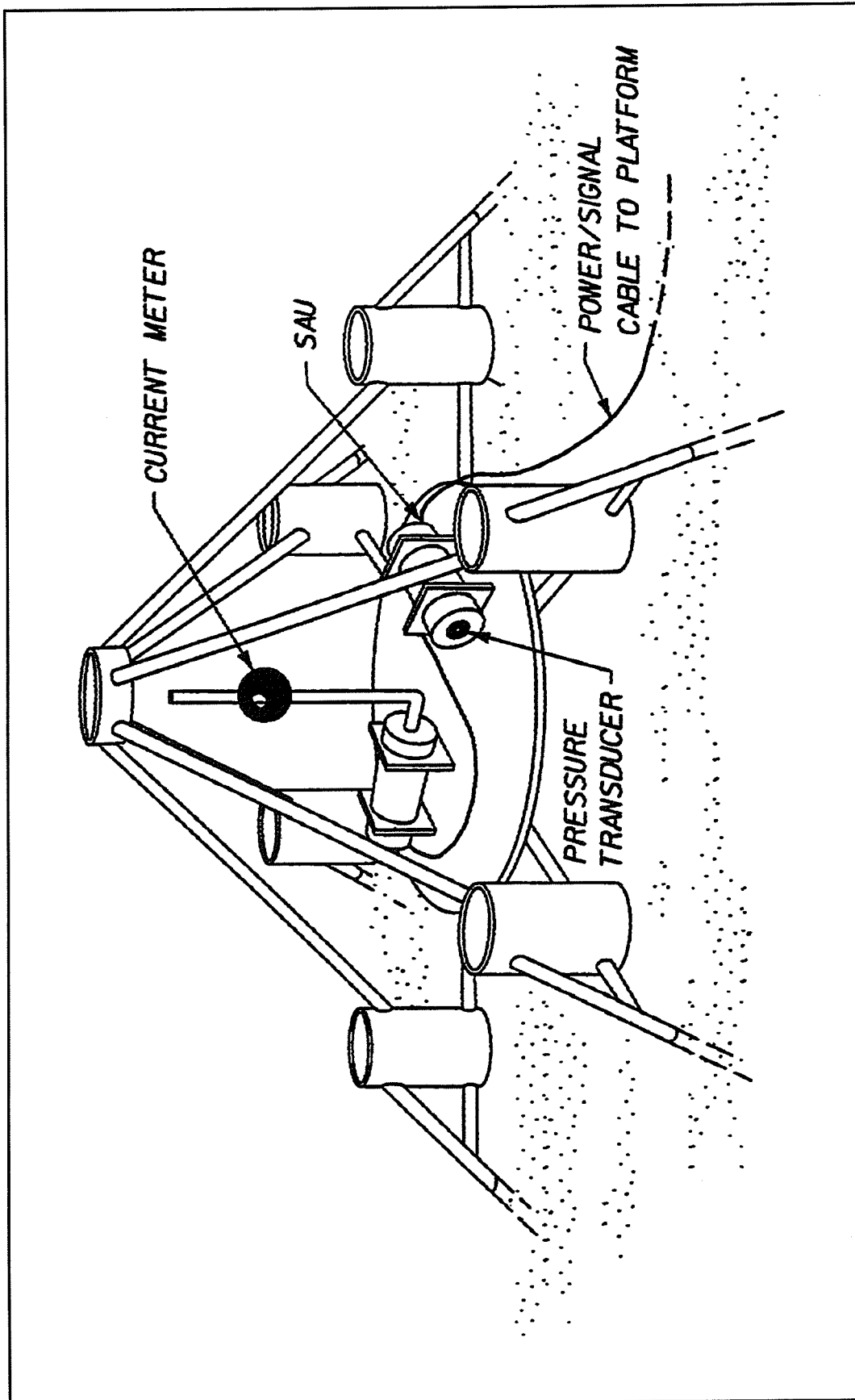

Figure 11. CERC-designed PUV in trawler-resistant mount

frame is assumed to be high in frequency relative to the wave orbital motions, and effectively eliminated by high-frequency cutoff in the analysis.

The gauge was tested prior to deployment in steady flow conditions in a 12-ft by 3-ft depth flume. A second electromagnetic current meter was positioned 1 ft upstream of the mount, and its output compared to that from the sensor mounted inside the frame for four different orientations of the frame. The x and y output voltage signals from each gauge were recorded on a paper strip chart and visually compared. No detectable difference was seen between the reference sensor and the in-mount sensor for any of the cases tested. Additional tests in oscillatory flow, with more sophisticated signal analysis, are recommended before dismissing the possibility that the frame affects the measured currents. The pressure signal can be assumed unaffected by the frame.

6 Results

Data Recovery

Table 1 illustrates the type and dates of data recovered for each gauge site. A typical output product of plotted and tabulated data from Site 1.5 for the January through April, 1989 deployment is contained in Appendix B. The complete data set is available through the Dredging Research Program (DRP) Program Manager at WES. Plate 2 is a sample for a portion of September, 1988. Analyzed directional spectra for each sample interval, as previously illustrated in Plate 1, are saved as digital ASCII files and are available from the DRP Program Manager at CERC. Archived data from the NDBC gauges are available from the National Oceanographic Data Center, 1825 Connecticut Avenue, NW, Washington, DC 20235.

Plates 3 and 4 are two examples of energy density and directional spectra from Site 4.1 while Hurricane Florence was transiting the Gulf of Mexico in September of 1988. On September 9, when the storm was in the southern Gulf, the peak of the spectrum was the 12.2-sec waves approaching from 198.5 deg true. Locally generated waves between 5 and 8 sec came from a more southeasterly direction. One day later, the storm was approaching landfall west of the study site. The peak had shifted downward in period to 9.5 sec, significant wave height had increased to almost 2 m, and most of the energy was coming from a more southerly direction. Both the swell and the wind waves had increased in size as the storm moved up the Gulf. Details of the storm track and the measured data are contained in Hands, Allison, and McKinney (1990).

There was one period of time, from June 27, 1989 to August 20, 1990, when simultaneous data sets were obtained at Site 1.5 from two internal recording gauges mounted on the same frame, separated by a distance of about 2.5 m. A comparison of these two data sets, designated 1.5A and 1.5B, illustrates some of the inherent difficulties in separating uncertainties in observations (measurement error) from process variability. Plates 5 and 6 are plots of wave height, period, and direction for the two gauges. At the scale of this plot, the gages show excellent agreement in most instances. Plate 7 is the residual, or difference, between the two

gauges for the three parameters shown in Plates 5 and 6. (To better illustrate the data near the mean, the vertical axis of the residual peak direction is limited to ± 20 deg, eliminating three outliers. The complete set of residual values, with means and standard deviations, is listed in Appendix C.)

Significant wave heights agree within a few centimeters, with a mean value for the residual of 0.6 cm and a standard deviation of 1.6 cm. While these values are quite small, the uncertainty associated with more extreme conditions can be larger. Peak direction shows more variability, more than 20 deg in three instances. This is partly an artifact caused by the use of a single parameter to represent a function in the frequency domain. Plates 8 and 9 are the energy and direction spectra for gauges 1.5A and 1.5B, respectively, for an instance showing 30 deg difference in peak direction. The energy spectrum for both gauges has two almost equal peaks; gauge 1.5A measured the left peak as "the" peak of the spectrum, gauge 1.5B the right. The two direction spectra are almost identical functions that show excellent agreement for the direction associated with each frequency band. Significant wave height is calculated from the integral of the energy spectrum, and this parameter only differs by 1 cm.

All but three of the cases where the difference in direction is greater than 10 deg are associated with a difference in peak period as well, and can also be explained by the above process. After eliminating the cases where the peak period differs, there is a remaining, nonzero residual, which is a better indication of the uncertainty in measuring direction. In the initial analysis, a bias of -3.7 deg was detected in the residual for those cases with zero residual peak period. The gauges were mounted on opposite sides of a steel frame mount whose orientation was measured in situ with an underwater electronic compass. Two supplementary readings were averaged to obtain the mount's orientation. A combination of compass error and departure of the mounting tabs from exact supplementary angles is the likely cause of the bias. It was compensated by splitting the 3.7 deg equally between the two measured gauge orientations, thus forcing the mean of the peak direction residual to zero (actual value is 0.07 deg, due to round-off errors). The standard deviation of this residual in direction is 3.2 deg, which is the combined effect of the uncertainty in the sensor and the processing, and the actual variance of the instantaneous water velocities over the 2.5-m separation.

The three remaining instances mentioned above when the peak direction differed most occurred under storm conditions when the significant wave height was greater than 1.7 m. Comparison of the spectra shows more variance in the directions at Site 1.5B, while those at Site 1.5A are more uniform (Plates 10-15). The gauges were aligned in a north - south line, with Site 1.5B north, and thus landward, of Site 1.5A. It could be assumed that the landward gauge was exposed to more turbulent conditions due to the landward flow of water around the other gauge and the mount when under the crest of the waves than was the seaward (southern) gauge when under the trough. This would imply that data from Site 1.5A were

more reliable. However, without controlled experiments to verify this hypothesis, it is recommended to assume the level of uncertainty, particularly in direction, increases during high wave conditions.

The effects of wider separation can be observed in simultaneous records from Sites 1.5A, 2, and 4.1 for the period 1-25 September 1989 (Plate 16). High, steep waves such as occurred on the 4th, tend to maintain their direction across the mounds. Lower, long waves refract more strongly, aligning with the local contours. On the 21st, for example, 12- to 13-sec waves approached from 180 deg on top of the active berm, and tended more from the southwest at Site 1.5. The buoy at Site 2 is exposed to waves from the northern quadrant when offshore winds prevail, while the two shallower gauges respond to lower, longer swell from the south (see September 17th and 23rd).

Failure Analysis

Data recovery from Area 1 using the internal recording gauges was about 50 percent from December 1986 to the planned removal at the end of FY 89. About 30 percent was downtime due to trawler damage, and 20 percent to instrument failure. Of the latter, about half can be attributed to a design characteristic in the gauge's pressure transducer that made it prone to failure in water with high suspended sediment concentrations (see McGehee (1989)).

The 50-percent return is typical in CERC's experience using these types of gauges. Beginning with Site 1.3, a redundant gauge was always deployed with the primary gauge. The use of two gauges gave improved return, with only a 1-month interval when both failed simultaneously. The most effective strategy in gauging Area 1 was abandoning it for the protection of the gas well.

Numerous attempts were made to mark the gauges in Area 1 with buoys, including full-size (6-ft-diam) U.S. Coast Guard navigation buoys. Official Notices to Mariners were published, and unofficial notices in English and Vietnamese (for the immigrant population) were circulated advising fishermen of the instruments, with little effect. The reason, disregarding a rather cavalier attitude by trawlers toward buoys, is that the area around the active berm proved to be excellent shrimping grounds.

The NDBC buoys had relatively good data return, 75 percent combined. Electronic failures were not excessive, but when they occurred, the logistics of changing a larger buoy at sea resulted in longer data gaps than were typical for the nearshore gauge replacements. Their ability to avoid trawler damage can be attributed to either size, or location in less productive fishing grounds, or both. Support for both buoys was terminated at the end of FY 90.

The CERC-designed system experienced numerous data dropouts between January and July, 1990, ranging from several hours to several days, caused by marginal performance of the solar power system. The unsealed lead-acid batteries readily lost electrolyte and experienced severe corrosion at the terminals. The entire 24-V battery pack was replaced twice in attempts to correct intermittent performance through the first half of 1990. There were insufficient funds at that point in the study to continue replacing or to redesign the battery system. The problem may have been related to defective batteries, maintenance procedures, or mismatch of the charge/discharge cycle to the batteries' characteristics.

The largest continuous data gaps in the CERC system occurred in October and November of 1989, and July and September of 1990, and were due to disk failure on the PMAB VAX 11-750 computer used to process and store data. Approximately 15 weeks of files resident since the previous backup were lost. While a loss to the project, this is not indicative of the performance of the CERC gauging system at Mobile. The data return of the CERC system was about 50 percent overall, but about 75 percent, neglecting the disk failures.

Conclusions

Directional wave, current, and water level data were obtained from four areas around two dredged material mounds placed offshore of Mobile, AL. A variety of gauges were utilized to meet different conditions. While commercially purchased gauges experienced high initial mortality, the necessary types and amounts of data from the required locations, as specified in the planning process, were successfully recovered.

A real-time system was designed and installed by CERC that made improvements in data return over commercially available, internal recording meters. Destruction by fishing trawlers was the principal failure mode of the bottom-mounted gauges before conversion to the trawler-resistant CERC design. In addition to being more robust, the CERC system's real-time telemetry assured capture of all data prior to any failure, and permitted rapid response to data loss. Most problems with the CERC system were related to the batteries of the commercially purchased solar power system.

A limited comparison that was made between adjacent gauges indicated the uncertainty in reduced wave parameters using PUV wave gauges in this environment. Significant wave heights were typically within a few centimeters. Peak directions showed occasional differences on the order of several tens of degrees for higher wave events or for bimodal spectra, but the standard deviation of the peak direction residual for the data set was less than 4 deg.

References

- Bradley, K. P., and Hands, E. B. (1989). "Dredged material underwater berms." *Proceedings of the 6th Symposium on Coastal and Ocean Management, Coastal Zone '89*. American Society of Civil Engineers, Charleston, SC, Vol 3, 2947-54.
- Douglass, S. L., Resio, D. T., and Hands, E. B. "Analysis of nearbed currents with an assessment of their impact on dredged material berms," in preparation, U.S. Army Engineer Waterways Experiment Station, Vicksburg, MS.
- Hands, E. B. (1991a). "Unprecedented migration of a submerged mound off the Alabama coast." *Proceedings of the Western Dredging Association Conference*, Las Vegas, NV.
- _____. (1991b). "Wide-area monitoring of material fate long after disposal." *Proceedings of the Marine Technology Society Conference*, New Orleans, LA, Vol 1, 98-105.
- _____. (1992a). "Monitoring of Alabama berms," *Dredging Research Technical Notes* DRP-1-08, U.S. Army Engineer Waterways Experiment Station, Vicksburg, MS.
- _____. (1992b). "Sediment and profile data collection." *Proceedings of the 1991 Corps of Engineers Regional Coastal Workshop*. Ann Arbor, MI, Engineering Circular 1110-2-272, U.S. Army Engineer Waterways Experiment Station, Vicksburg, MS.
- _____. (1994). "Shoreward movement and other 5-year changes at Sand Island, Alabama." *Proceedings of the Western Dredging Association Conference*. San Diego, CA, Center for Dredging Studies, College Station, TX.
- Hands, E. B., Allison, M. C., and McKinney, J. P. (1990). "Dispersion of waves from Hurricane Gilbert and their intermittent reception on the Alabama coast." *Proceedings of the 22nd Annual Offshore Technology Conference*, Houston, TX, Vol 2, 259-66.

- Hands, E. B., and Allison, M. C. (1991). "Mound migration in deeper water and methods of categorizing active and stable depths." *Proceedings of a Specialty Conference on Quantitative Approaches to Coastal Sediment Processes, Coastal Sediments '91*, N. C. Kraus, ed., American Society of Civil Engineers, Seattle, WA, Vol 2, 1985-99.
- Hands, E. B., and Bradley, K. P. (1989). "Results of monitoring the disposal berm at Sand Island, Alabama; Report 1, Construction of the Sand Island construction and first year's monitoring response," TR DRP-90-2, U.S. Army Engineer Waterways Experiment Station, Vicksburg, MS.
- Hands, E. B., and Resio, D. T. (1994). "Empirical guidance for siting berms to promote stability or nourishment benefits." *Proceedings of the 2nd International Conference on Dredging and Dredged Material Placement*. Buena Vista, FL, American Society of Civil Engineers, NY.
- Kinsman, B. (1965). *Wind waves their generation and propagation on the ocean surface*. Prentice Hall, Englewood Cliffs, NJ.
- Kraus, N. C., ed. (1991). "Mobile, Alabama, field data collection project, 18 August - 2 September, 1989; Report 1, Dredged material plume survey data report," Technical Report DRP-91-3, U.S. Army Engineer Waterways Experiment Station, Vicksburg, MS.
- Longuet-Higgins, M. S., Cartwright, D. E., and Smith, N. D. (1963). "Observations of the directional spectrum of sea waves using the motions of a floating buoy." *Ocean Wave Spectra*, 111-36.
- McGehee, David D. (1989). "Modification to sea data wave gages for coastal use," Coastal Engineering Technical Note I-9, U.S. Army Engineer Waterways Experiment Station, Vicksburg, MS.
- _____. (1990). "A remote measurement system for monitoring waves and currents at an offshore dredge disposal site," Coastal Engineering Technical Note I-11, U.S. Army Engineer Waterways Experiment Station, Vicksburg, MS.
- McLellan, T. N., and Imsand, F. D. (1989). "Berm construction utilizing dredged material." *Proceedings of WODCONXII*, Western Dredging Association, 811-20.
- Phillips, O. M. (1977). *The dynamics of the upper ocean*. 2nd ed., Cambridge University Press, Cambridge, U.K.
- Shore protection manual*. (1984). 4th ed., 2 Vol, U.S. Army Engineer Waterways Experiment Station, U.S. Government Printing Office, Washington, DC.

Steele, K. E., Wang, D. W., Teng, C., and Lang, N. C. (1990).
"Directional wave measurements with NDBC 3-meter discus buoys,"
1804-01.05, U.S. Department of Commerce, National Data Buoy
Center, Stennis Space Center, MS.

U.S. Coast Guard. 1975 ed. (plus changes 1975-1986). *The aids to
navigation manual-technical*. Department of Transportation,
Washington, DC.

SAND ISLAND, MOBILE, ALABAMA
30.18 N, 88.07 W

MM	DY	YR	HRMN	Hmo	TP	Dp	AVE. CUR	MAX. CUR	MED. CUR	STOV	UMEAN	VMEAN	C. DIR	DEPTH
				(M)	(SEC)	(DEG)	(M/SEC)	(M/SEC)	(M/SEC)	(M/SEC)	(M/SEC)	(M/SEC)	(DEG)	(M)
9	10	88	500	2.71	9.5	264	6.07	7.83	6.56	1.40	-1.24	1.30	223	6.4
9	10	88	1100	2.32	7.8	220	1.85	3.30	1.89	0.60	-0.13	0.26	206	6.2
9	10	88	1700	1.95	9.5	197	1.32	1.27	1.27	0.61	-0.01	0.22	182	6.2
9	10	88	2300	1.60	7.8	204	0.99	3.24	0.92	0.54	-0.05	0.13	201	6.1
9	11	88	500	1.35	6.6	178	0.81	2.21	0.76	0.42	-0.05	0.11	204	6.1
9	11	88	1100	0.95	6.2	188	0.50	1.64	0.46	0.39	-0.04	0.02	243	6.1
9	11	88	1700	0.56	6.6	178	0.29	0.83	0.28	0.13	-0.01	-0.03	341	6.1
9	11	88	2300	0.53	4.2	118	0.46	1.11	0.46	0.16	0.02	0.12	170	6.1
9	12	88	500	0.45	5.2	170	0.23	0.78	0.21	0.12	0.00	0.01	180	6.2
9	12	88	1100	0.43	5.0	127	0.27	0.85	0.24	0.15	-0.01	0.00	270	6.2
9	12	88	1700	0.55	5.4	122	0.26	0.79	0.24	0.15	-0.01	0.19	180	6.1
9	12	88	2300	0.61	4.2	147	0.68	1.26	0.68	0.19	0.00	0.19	270	6.1
9	13	88	500	0.77	6.6	176	0.44	1.51	0.41	0.24	-0.01	-0.01	315	6.2
9	13	88	1100	0.88	7.8	181	0.67	1.98	0.64	0.32	-0.01	0.11	185	6.0
9	13	88	1700	0.66	7.3	156	0.38	1.20	0.35	0.22	-0.01	-0.01	315	6.2
9	13	88	2300	0.45	6.9	146	0.41	0.89	0.40	0.16	0.00	0.10	180	6.1
9	14	88	500	0.57	6.2	160	0.33	1.12	0.30	0.19	0.01	0.02	153	6.2
9	14	88	1100	0.82	6.9	165	0.67	2.01	0.65	0.33	-0.05	0.13	201	6.0
9	14	88	1700	0.96	8.3	191	0.55	1.83	0.49	0.33	-0.01	-0.02	313	6.1
9	14	88	2300	1.01	7.3	168	0.73	2.13	0.86	0.40	-0.10	0.09	228	6.2
9	15	88	500	1.67	8.3	183	1.09	3.38	1.02	0.58	-0.04	0.05	218	6.4
9	15	88	1100	2.02	13.5	176	1.65	3.43	1.70	0.64	0.01	0.21	177	6.1
9	15	88	1700	2.41	9.5	220	1.78	3.51	1.82	0.66	-0.04	0.15	190	6.1
9	15	88	2300	2.64	7.8	224	1.79	3.41	1.37	0.70	-0.09	0.15	210	6.6
9	16	88	500	2.33	11.1	210	1.44	3.41	1.37	0.70	-0.09	0.15	210	6.6
9	16	88	1100	1.98	10.2	145	1.81	3.44	1.86	0.57	-0.05	0.30	189	6.2
9	16	88	1700	2.39	11.1	174	2.02	3.54	2.07	0.61	-0.19	0.21	222	6.2
9	16	88	2300	2.46	13.5	224	1.96	3.43	1.97	0.72	-0.17	0.33	207	6.2
9	17	88	500	2.43	15.1	211	1.61	3.45	1.57	0.61	-0.17	0.33	205	6.5
9	17	88	1100	2.00	13.5	213	1.60	3.40	1.64	0.66	-0.11	0.26	202	6.2
9	17	88	1700	1.43	11.1	215	1.06	3.13	1.00	0.54	-0.07	0.15	205	6.0
9	17	88	2300	1.17	7.8	200	0.75	2.50	0.70	0.40	-0.03	-0.07	336	6.2
9	18	88	500	1.15	7.3	189	0.69	2.00	0.61	0.39	0.05	0.01	101	6.5
9	18	88	1100	1.03	7.3	201	0.69	2.29	0.63	0.37	0.01	0.11	174	6.2
9	18	88	1700	0.73	6.6	178	0.47	1.47	0.43	0.27	-0.05	-0.03	300	5.8
9	18	88	2300	0.66	6.0	176	0.42	1.22	0.40	0.22	-0.05	-0.05	329	6.0
9	19	88	500	0.57	6.2	176	0.43	1.10	0.42	0.18	-0.03	-0.03	341	6.3
9	19	88	1100	0.53	6.9	179	0.62	0.61	0.29	0.18	-0.09	-0.03	80	6.3
9	19	88	1700	0.44	6.6	210	0.29	0.91	0.28	0.15	-0.01	0.02	206	5.9
9	19	88	2300	0.40	6.9	202	0.26	0.96	0.24	0.14	0.02	-0.02	45	5.9
9	20	88	500	0.38	6.9	189	0.66	1.09	0.66	0.14	-0.02	-0.19	353	6.3
9	20	88	1100	0.44	6.9	173	0.87	1.73	0.86	0.22	0.20	-0.16	51	6.3
9	20	88	1700	0.34	7.3	182	0.24	0.77	0.22	0.13	0.01	-0.01	45	5.9
9	20	88	2300	0.27	6.6	199	0.28	0.64	0.27	0.12	-0.01	-0.07	351	5.9
9	21	88	500	0.28	8.3	207	0.60	0.98	0.59	0.13	-0.06	-0.17	310	6.2

MOBILE, ALABAMA
30.18 N, 88.07 W

PEAK DIRECTION, DEG = 198.5

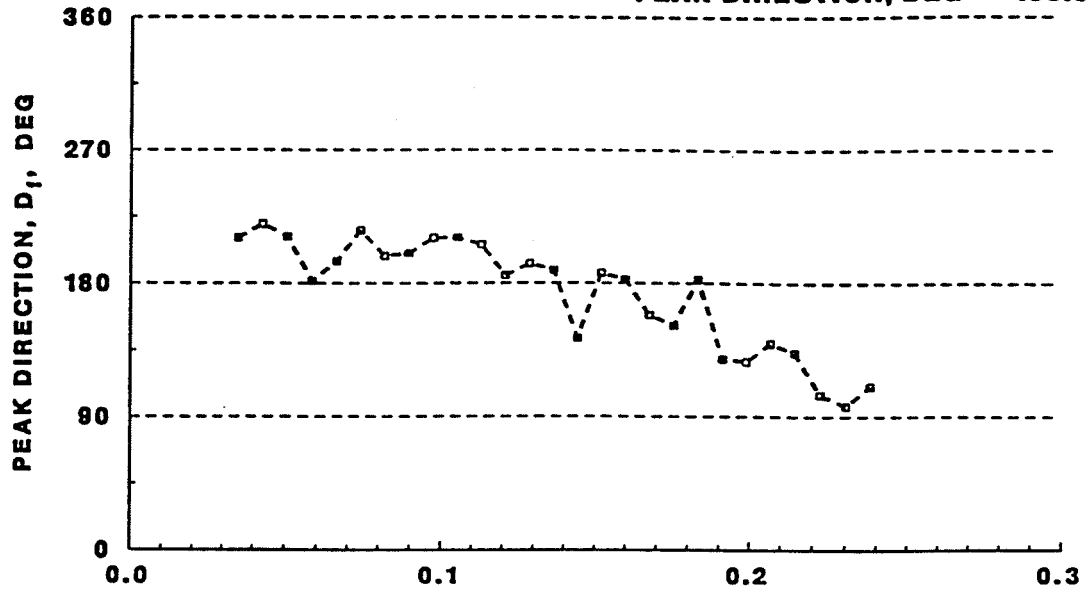

PEAK PERIOD, T_p, SEC = 12.2
WAVE HEIGHT, H_{m0}, M = 1.76

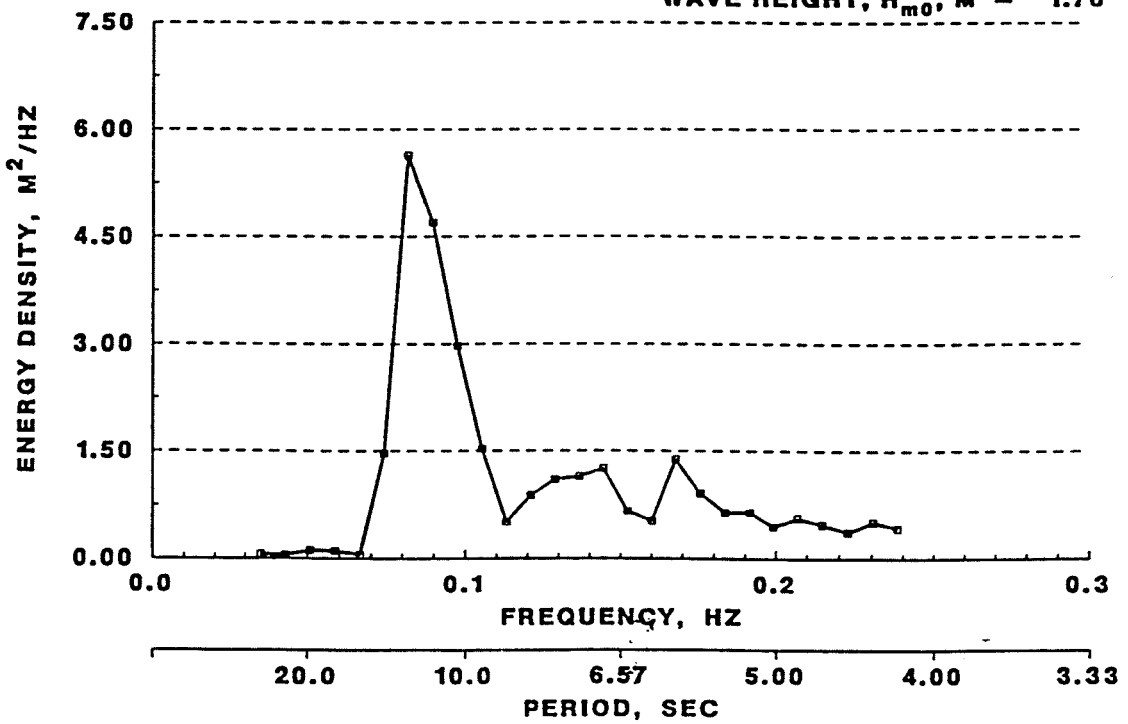

ENERGY SPECTRUM 9/ 9/88 1700

MOBILE, ALABAMA
30.18 N, 88.07 W

PEAK DIRECTION, DEG = 187.4

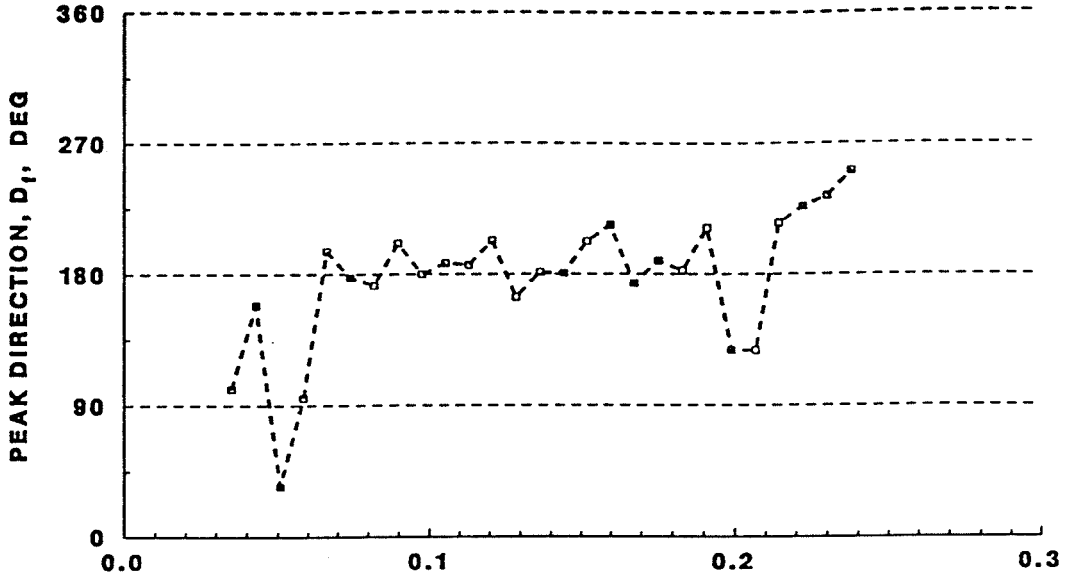

PEAK PERIOD, T_p, SEC = 9.48
WAVE HEIGHT, H_{m0}, M = 1.95

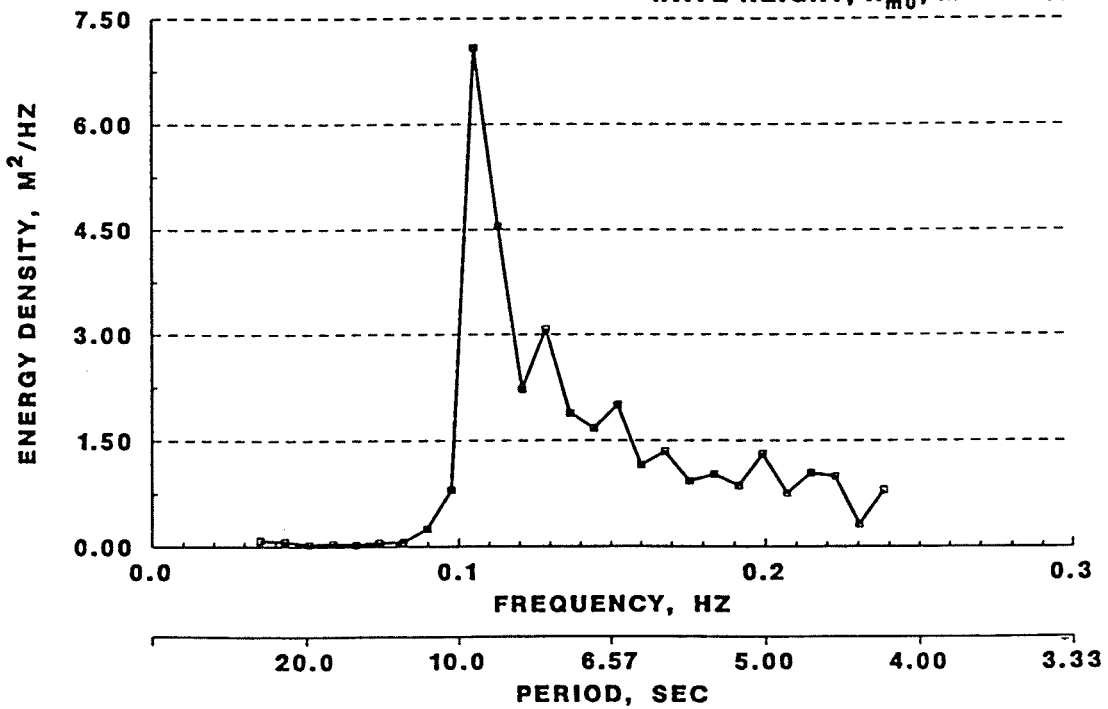

ENERGY SPECTRUM 9/10/88 1700

MOBILE, ALABAMA
SITE 1.5A, 30.175 N, 88.067 W

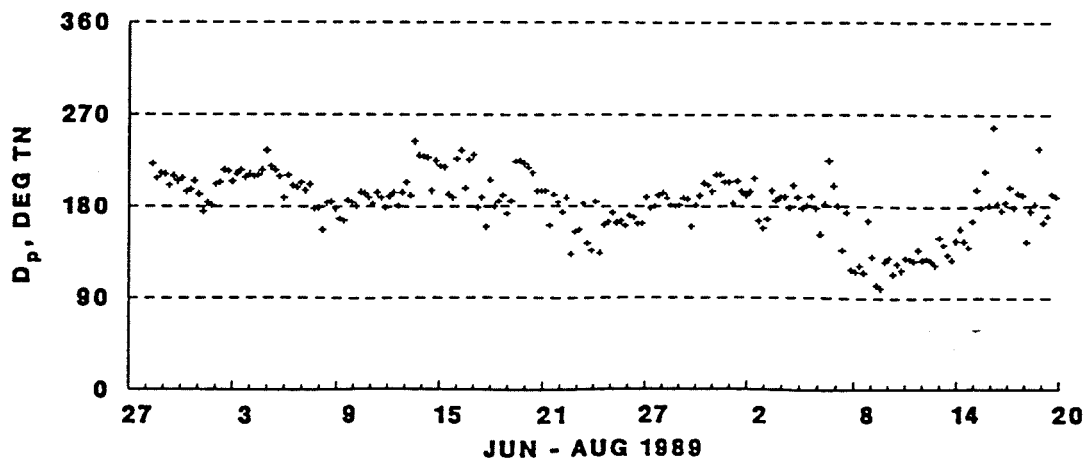
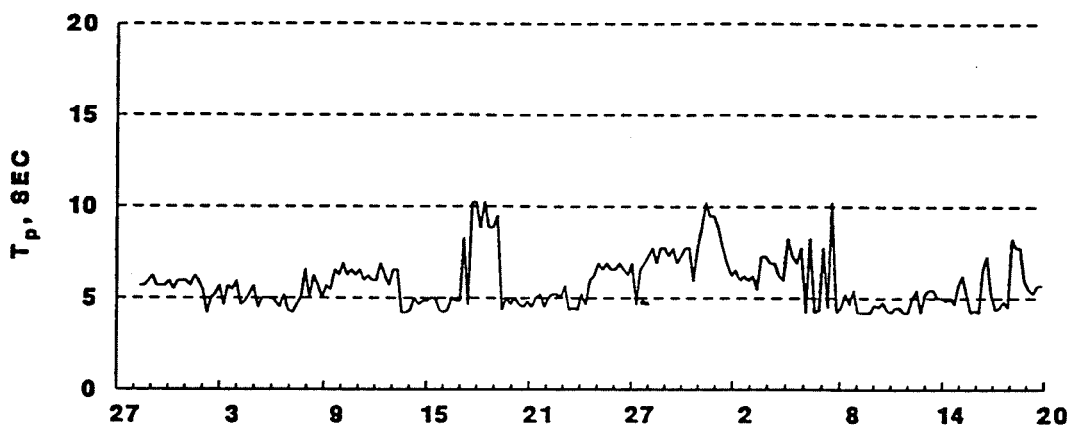
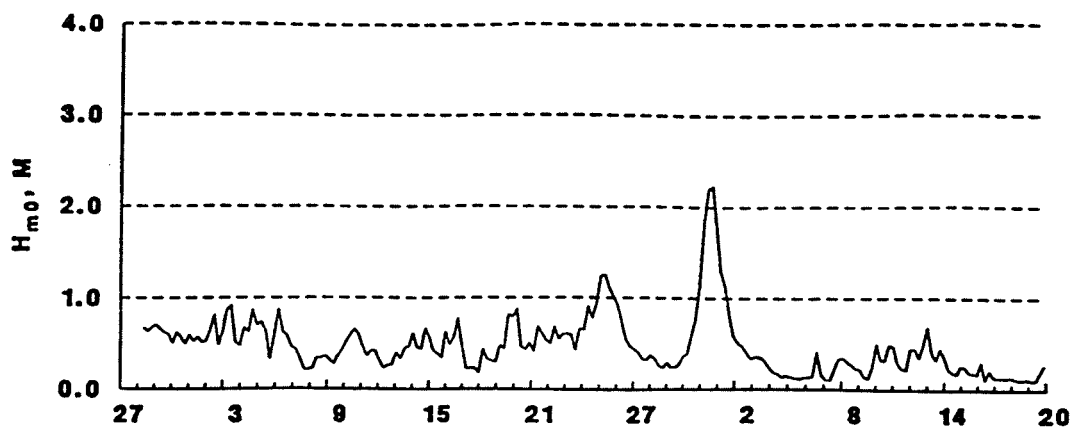

JUN - AUG 1989

**MOBILE, ALABAMA
SITE 1.5B, 30.175 N, 88.067 W**

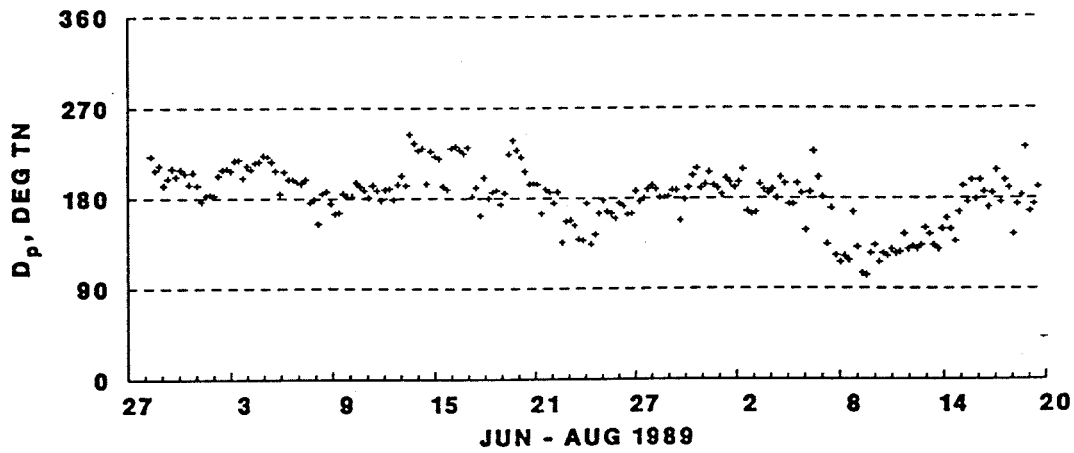
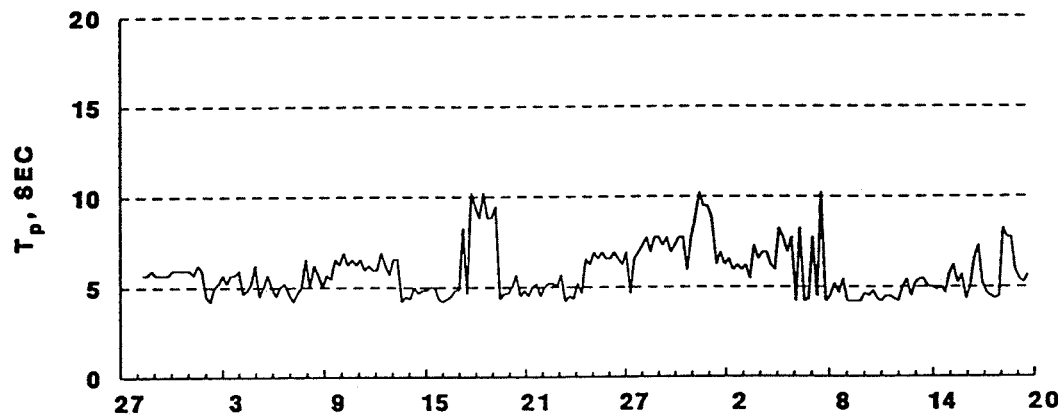
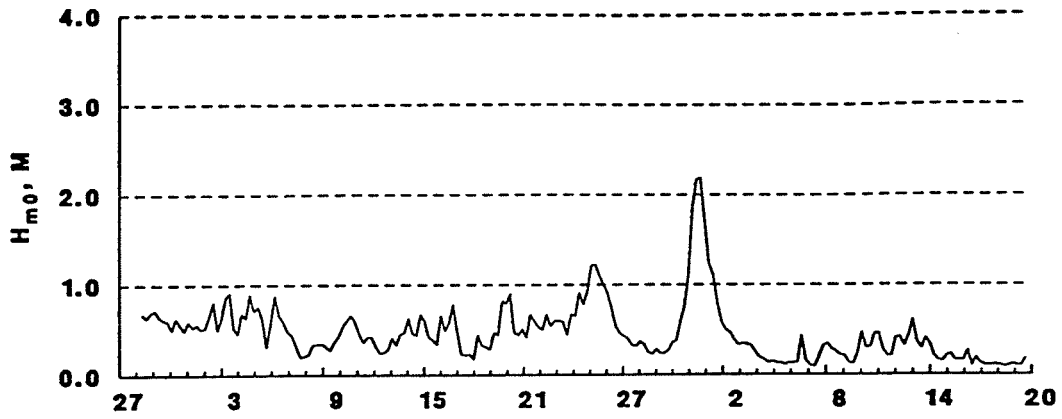

JUN - AUG 1989

**RESIDUAL TIMESERIES
SITE 1.5A - SITE 1.5B**

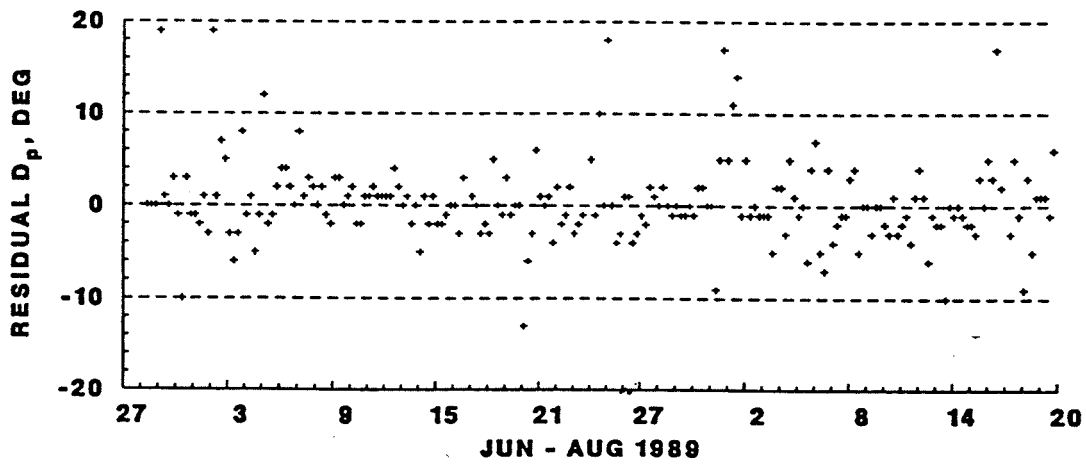
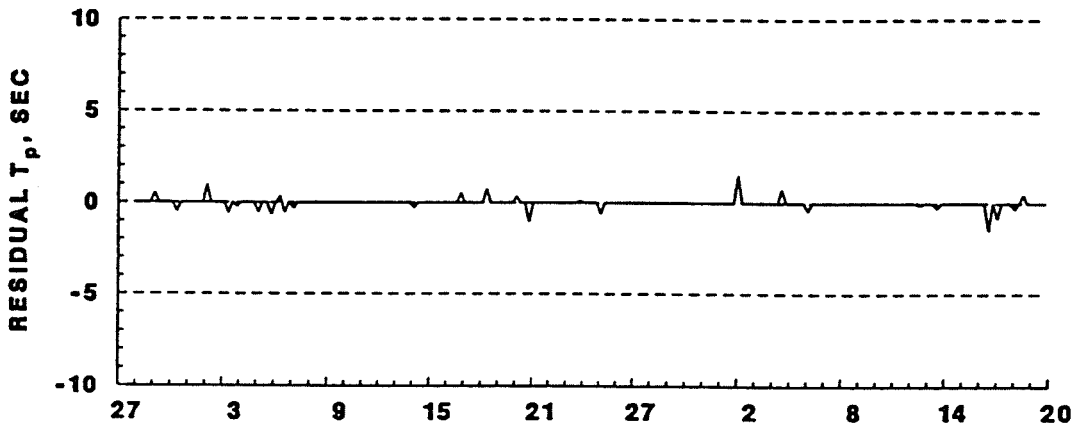
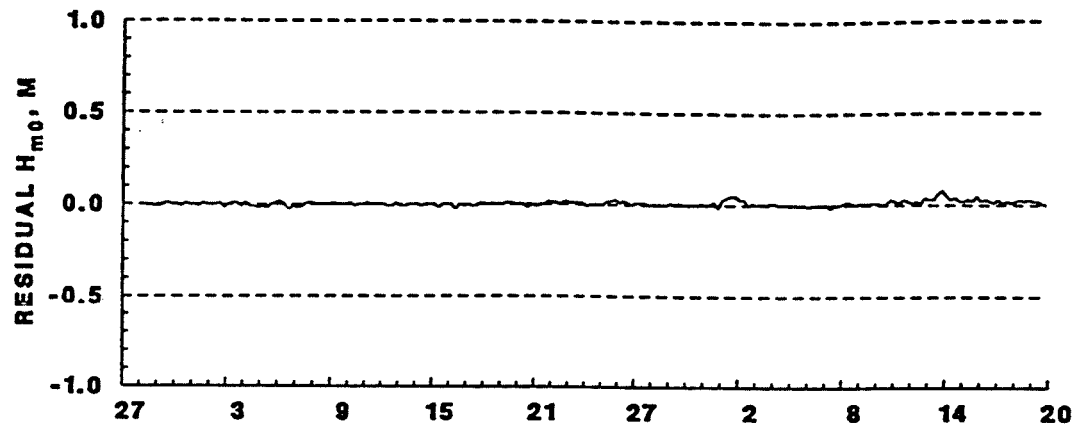

**MOBILE, ALABAMA
SITE 1.5A, 30.179 N, 88.065 W**

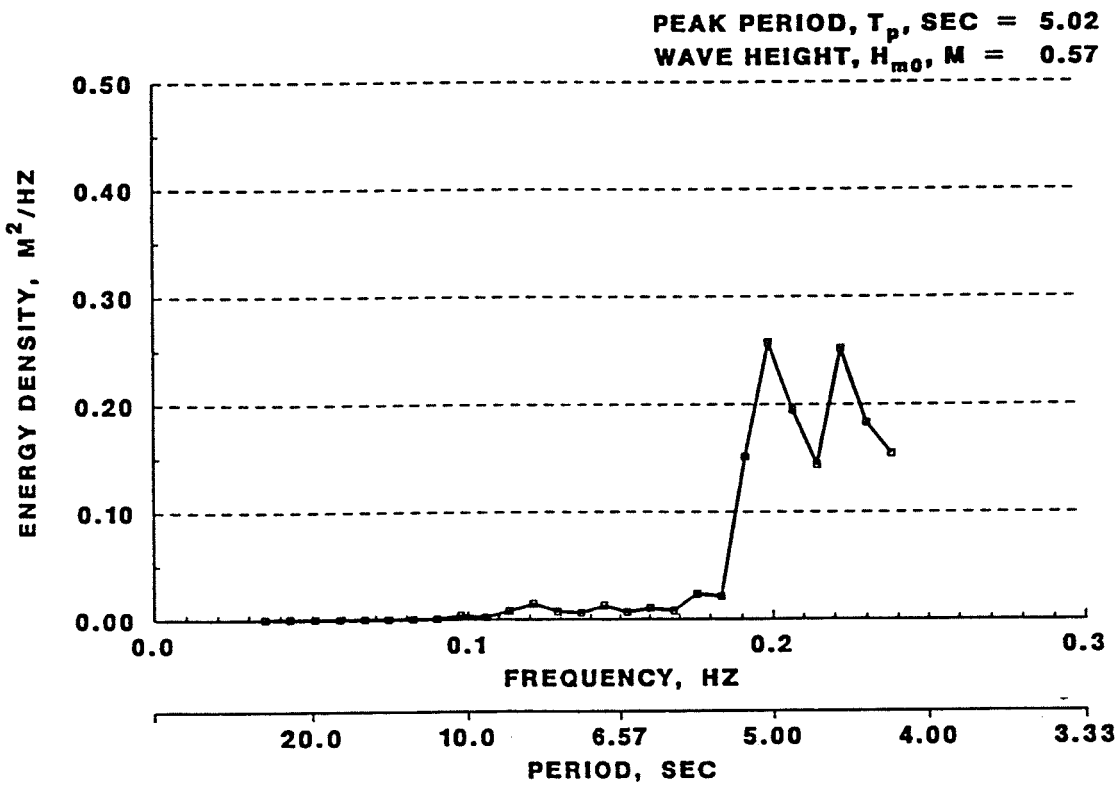
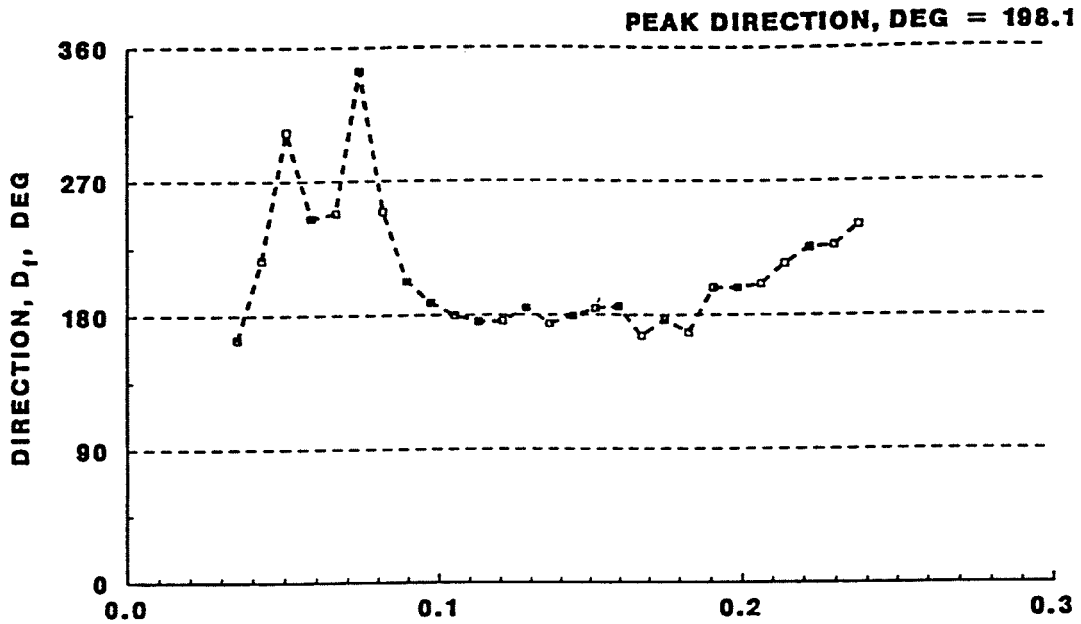

ENERGY SPECTRUM 7/16/89 2100

MOBILE, ALABAMA
SITE 1.5B, 30.179 N, 88.065 W

PEAK DIRECTION, DEG = 228.5

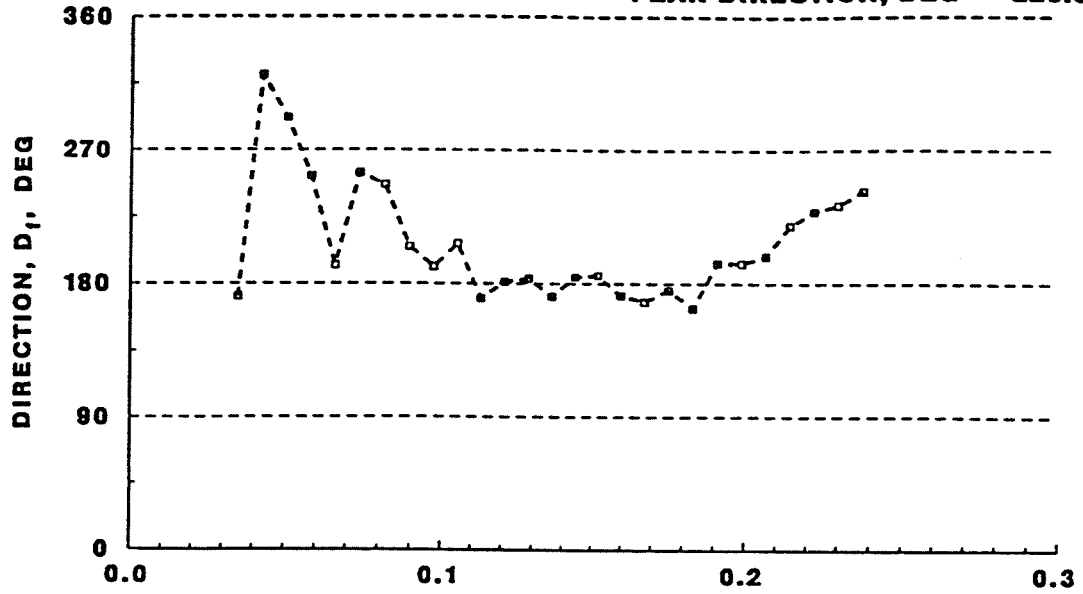

PEAK PERIOD, T_p, SEC = 4.49

WAVE HEIGHT, H_{m0}, M = 0.58

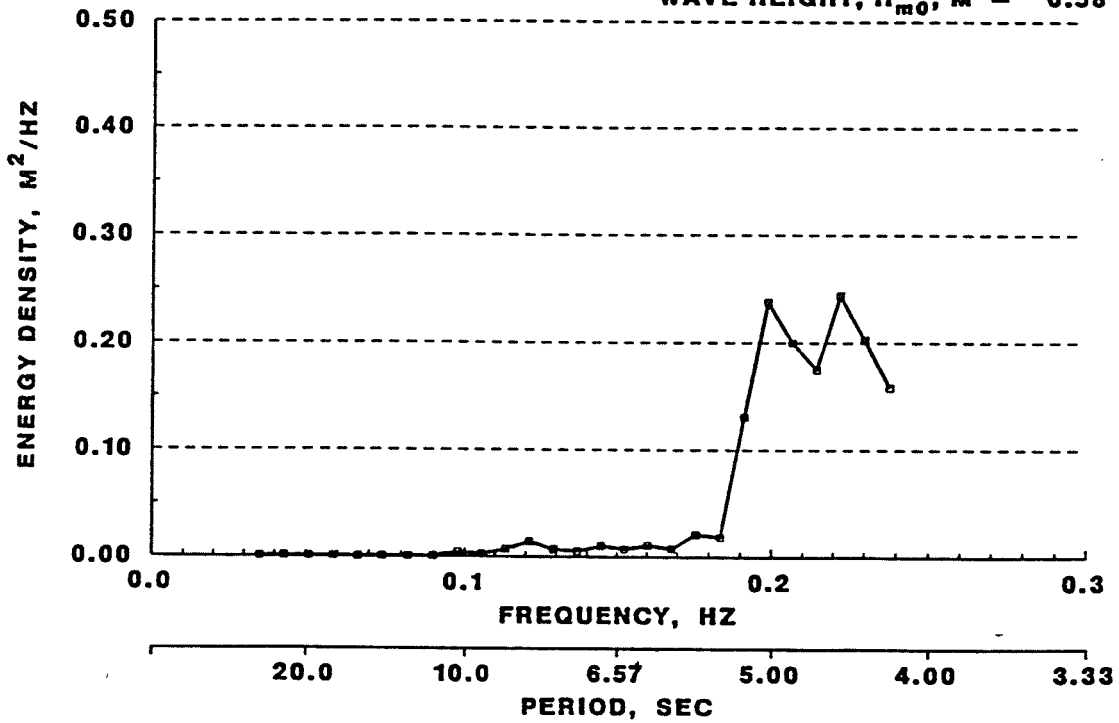

ENERGY SPECTRUM 7/16/89 2100

**MOBILE, ALABAMA
SITE 1.5A, 30.175 N, 88.067 W**

PEAK DIRECTION, DEG = 211.4

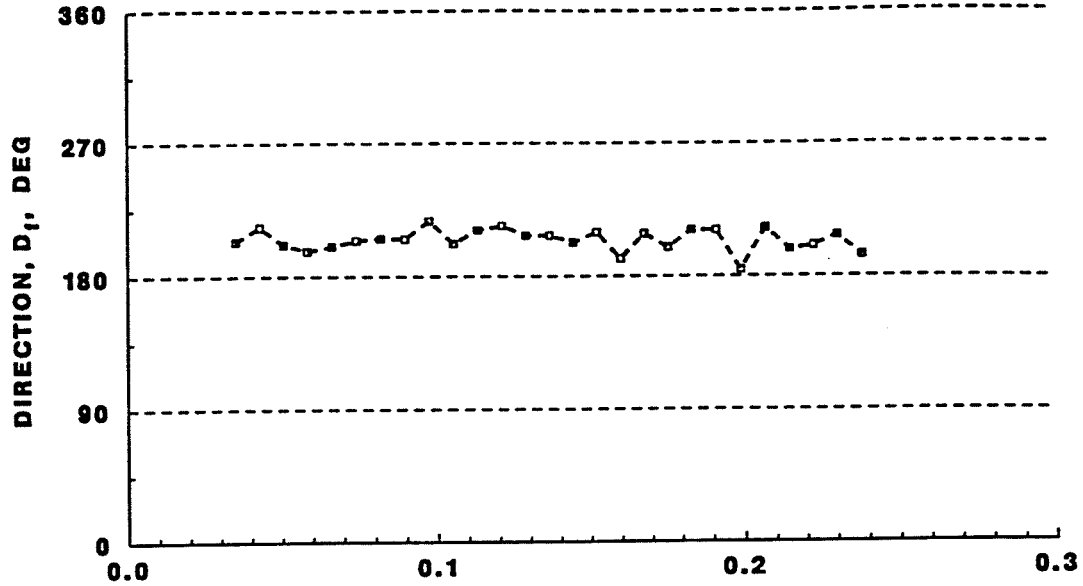

**PEAK PERIOD, T_p, SEC = 8.83
WAVE HEIGHT, H_{m0}, M = 1.83**

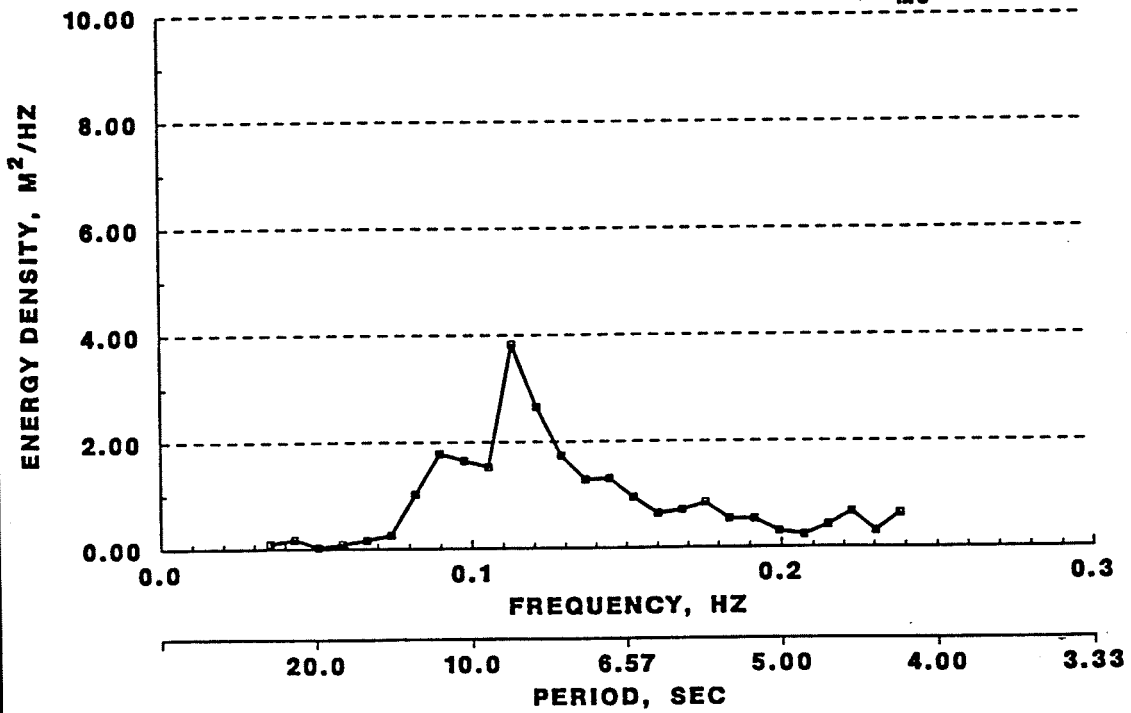

ENERGY SPECTRUM 7/31/89 2100

**MOBILE, ALABAMA
SITE 1.5B, 30.175 N, 88.067 W**

PEAK DIRECTION, DEG = 194.9

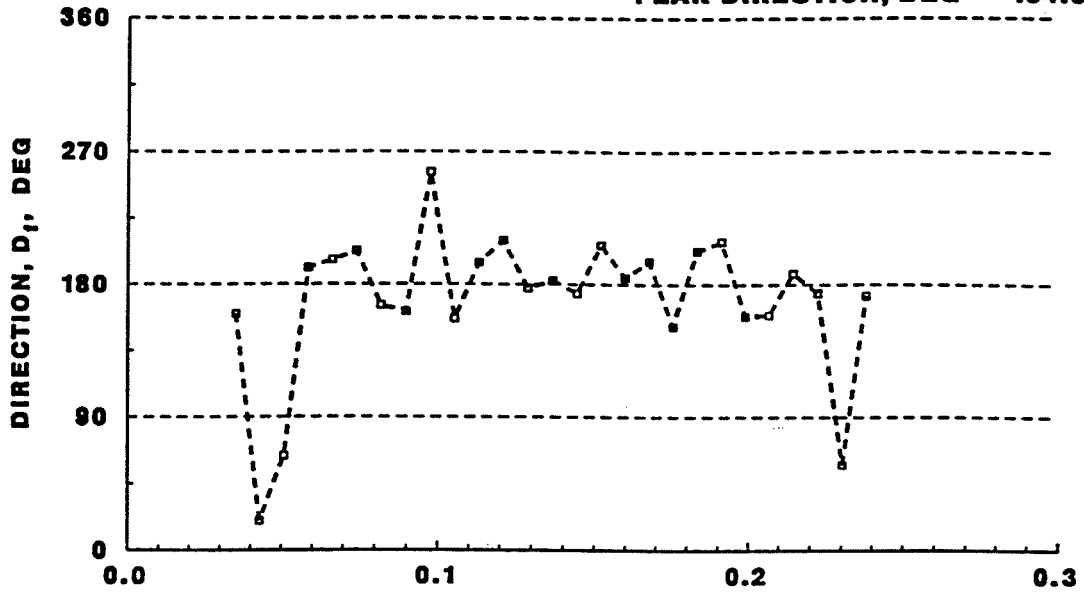

**PEAK PERIOD, T_p, SEC = 8.83
WAVE HEIGHT, H_{m0}, M = 1.85**

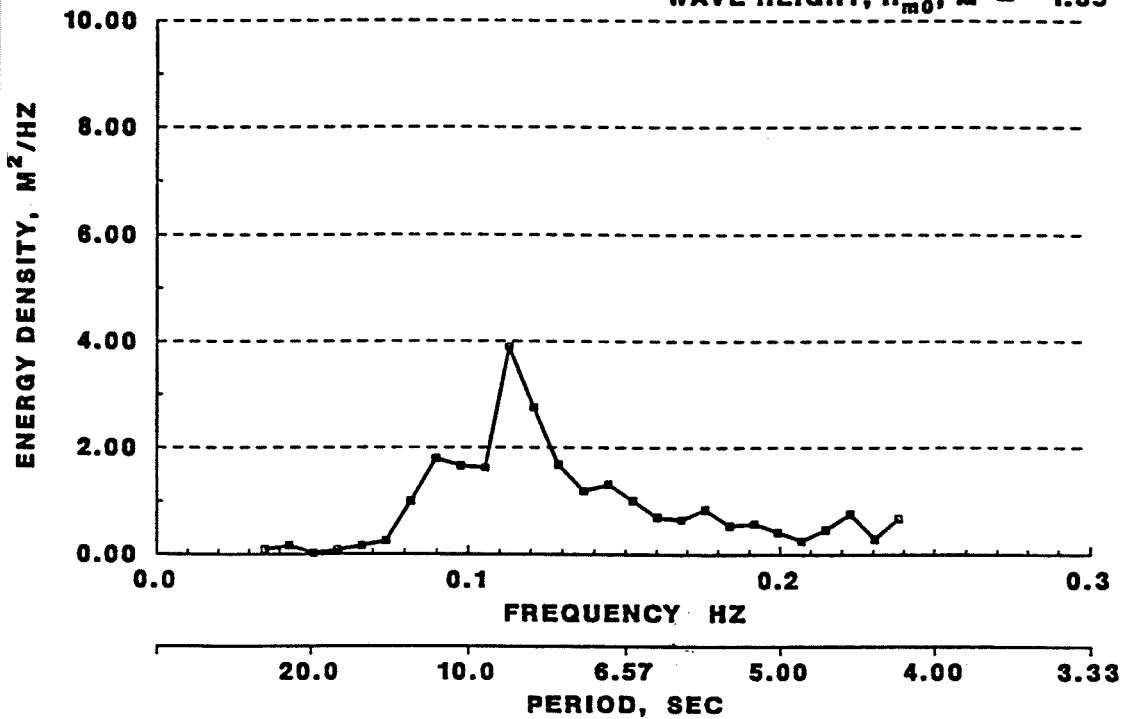

ENERGY SPECTRUM 7/31/89 2100

**MOBILE, ALABAMA
SITE 1.5A, 30.175 N, 88.067 W**

PEAK DIRECTION, DEG = 204.8

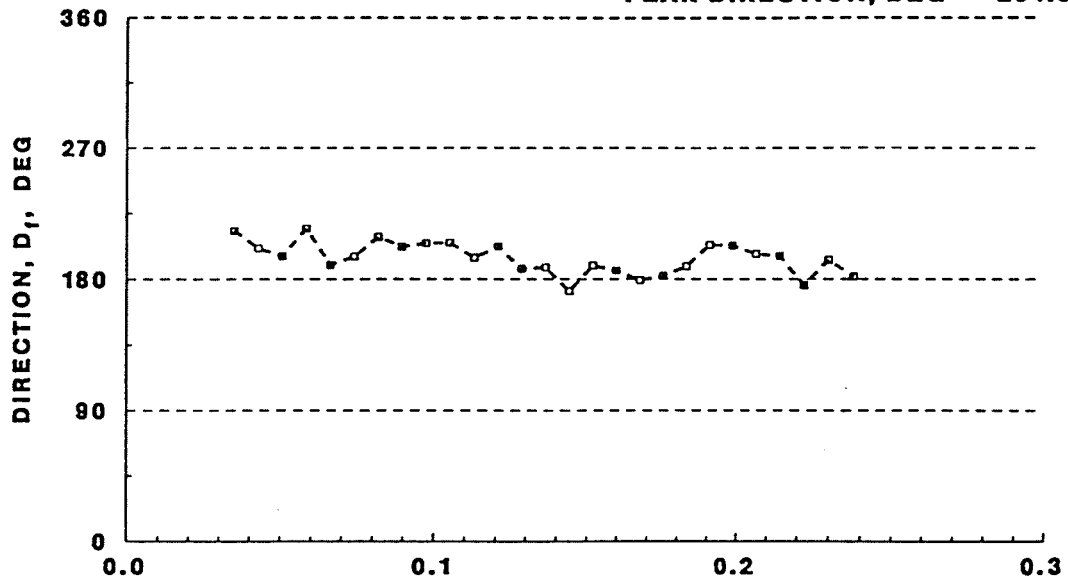

**PEAK PERIOD, T_p, SEC = 9.48
WAVE HEIGHT, H_{m0}, M = 2.23**

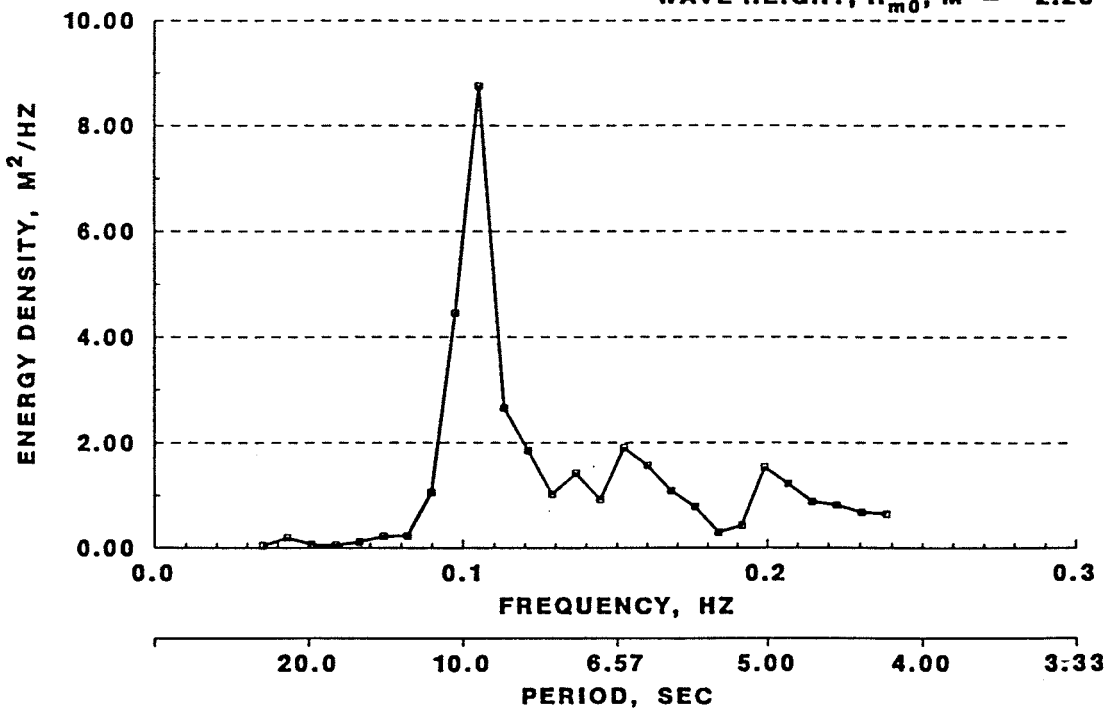

ENERGY SPECTRUM 8/ 1/89 900

MOBILE, ALABAMA
SITE 1.5B, 30.175 N, 88.067 W

PEAK DIRECTION, DEG = 193.7

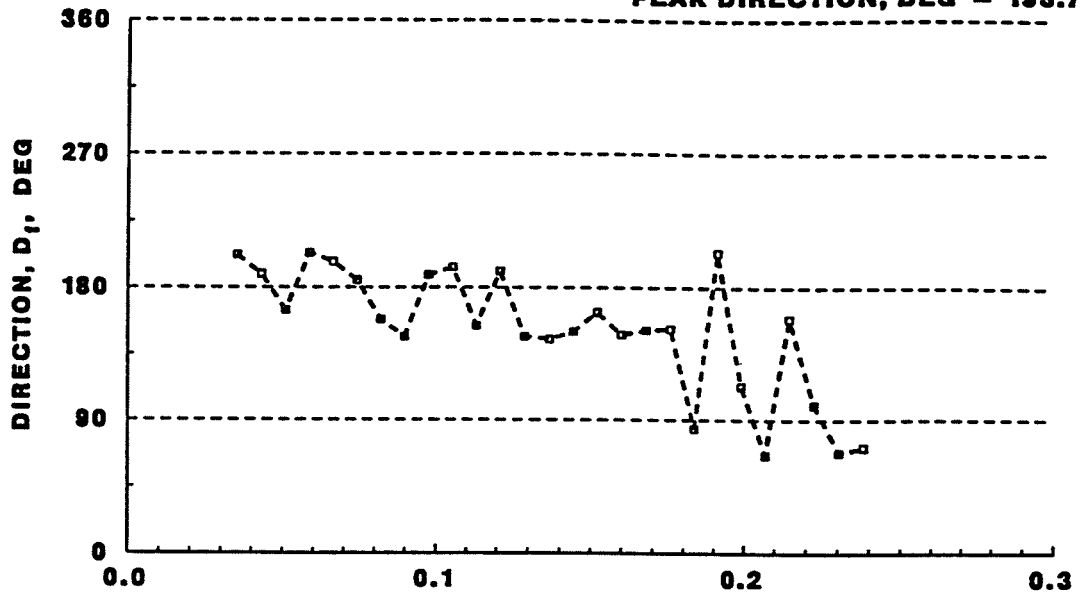

PEAK PERIOD, T_p, SEC = 9.48

WAVE HEIGHT, H_{ms0}, M = 2.19

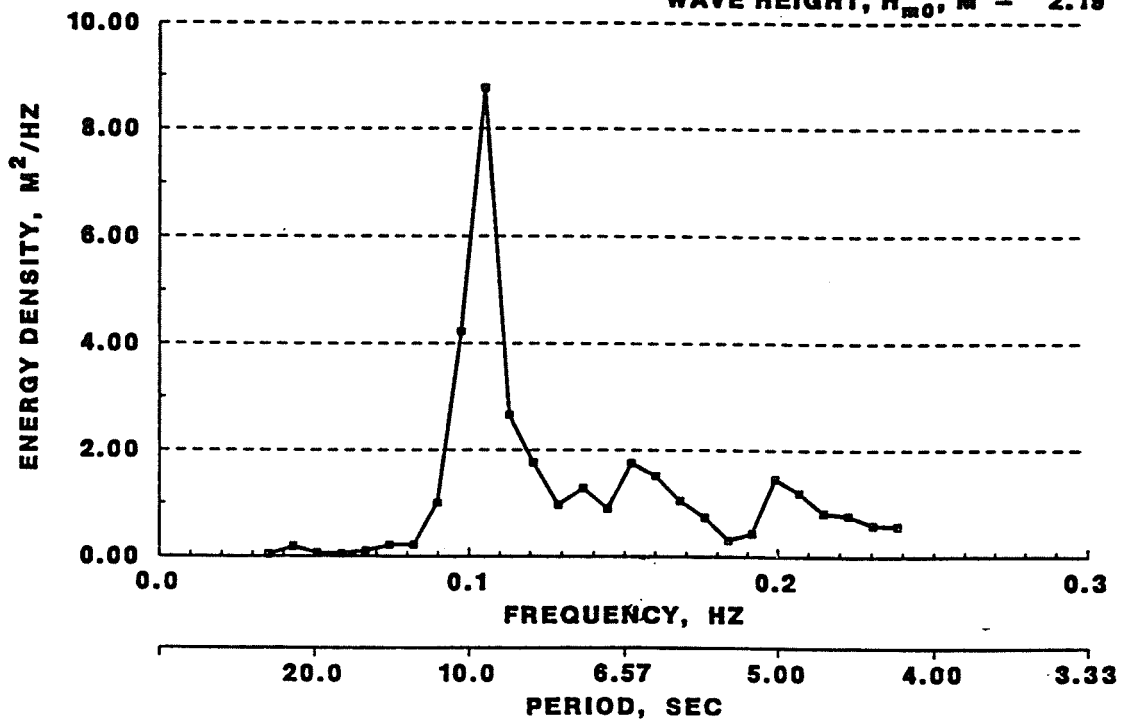

ENERGY SPECTRUM 8/ 1/89 900

MOBILE, ALABAMA
SITE 1.5A, 30.175 N, 88.067 W

PEAK DIRECTION, DEG = 204.8

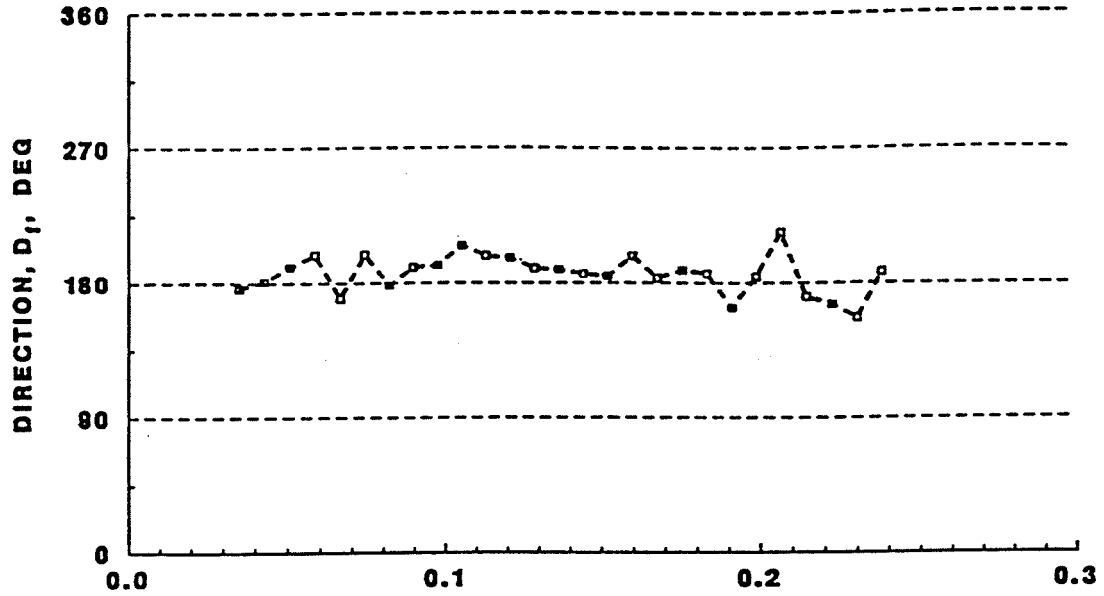

PEAK PERIOD, T_p, SEC = 9.48
WAVE HEIGHT, H_{m0}, M = 1.77

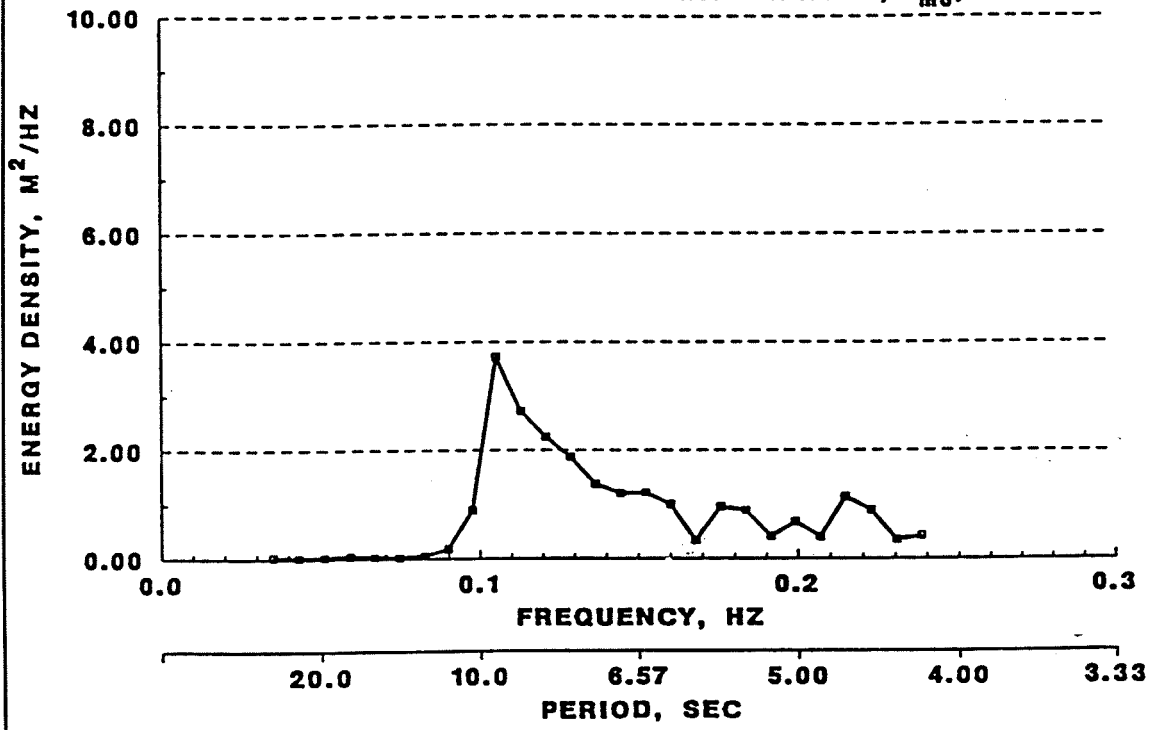

ENERGY SPECTRUM 8/ 1/89 1500

MOBILE, ALABAMA
SITE 1.5B, 30.175 N, 88.067 W

PEAK DIRECTION, DEG = 190.4

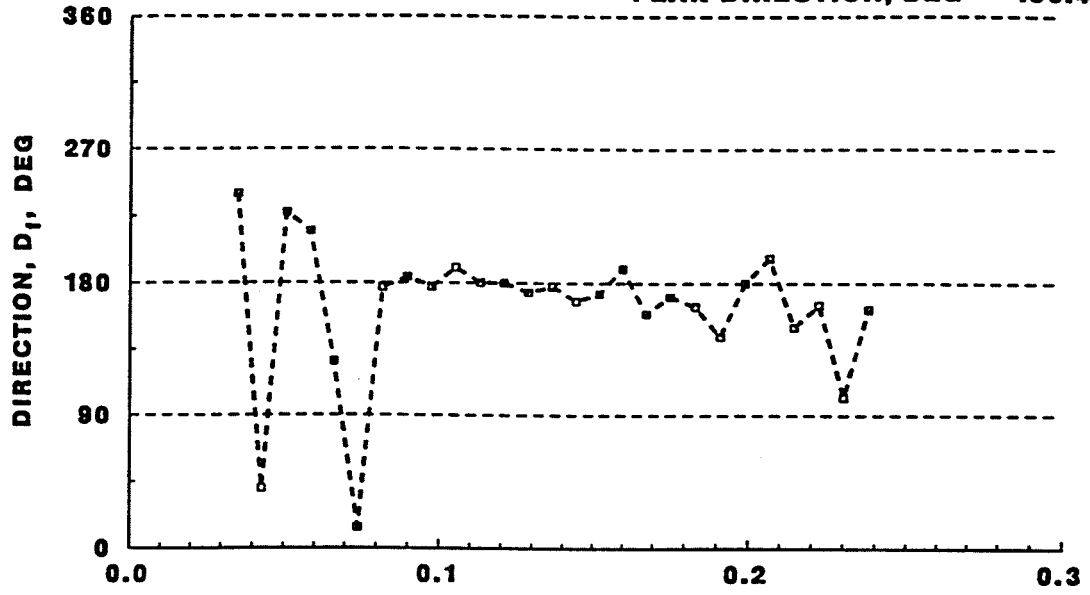

PEAK PERIOD, T_p, SEC = 9.48
WAVE HEIGHT, H_{m0}, M = 1.72

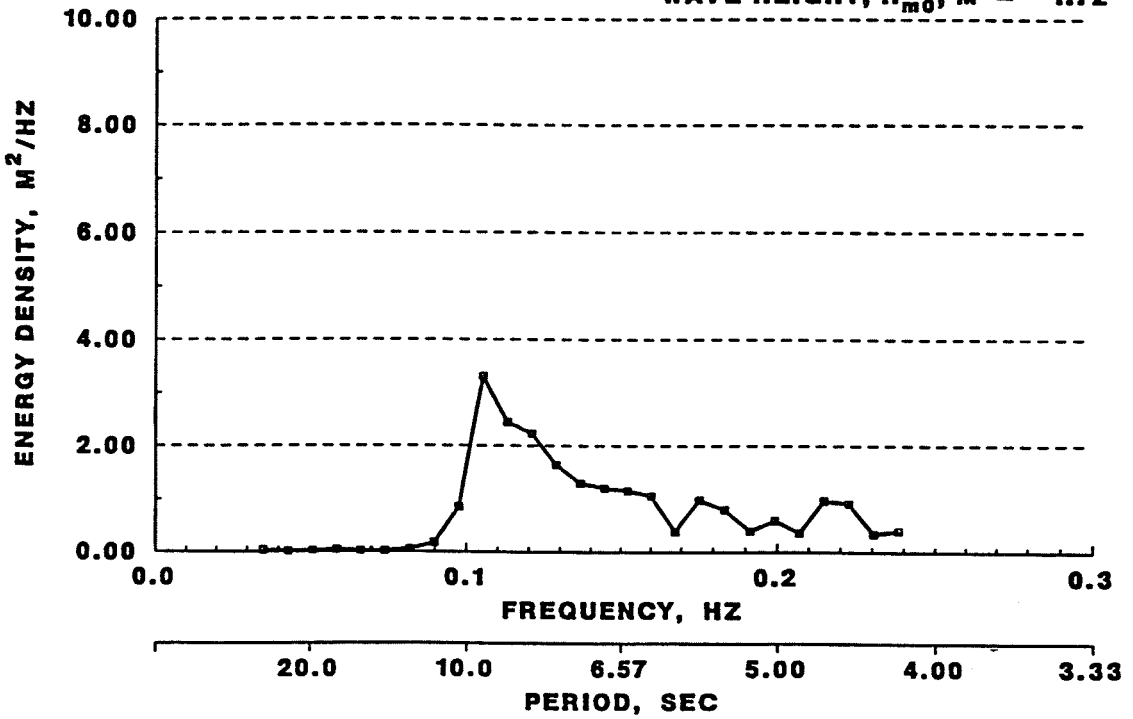

ENERGY SPECTRUM 8/ 1/89 1500

MOBILE, ALABAMA DIRECTIONAL WAVE STATISTICS COMPARISON

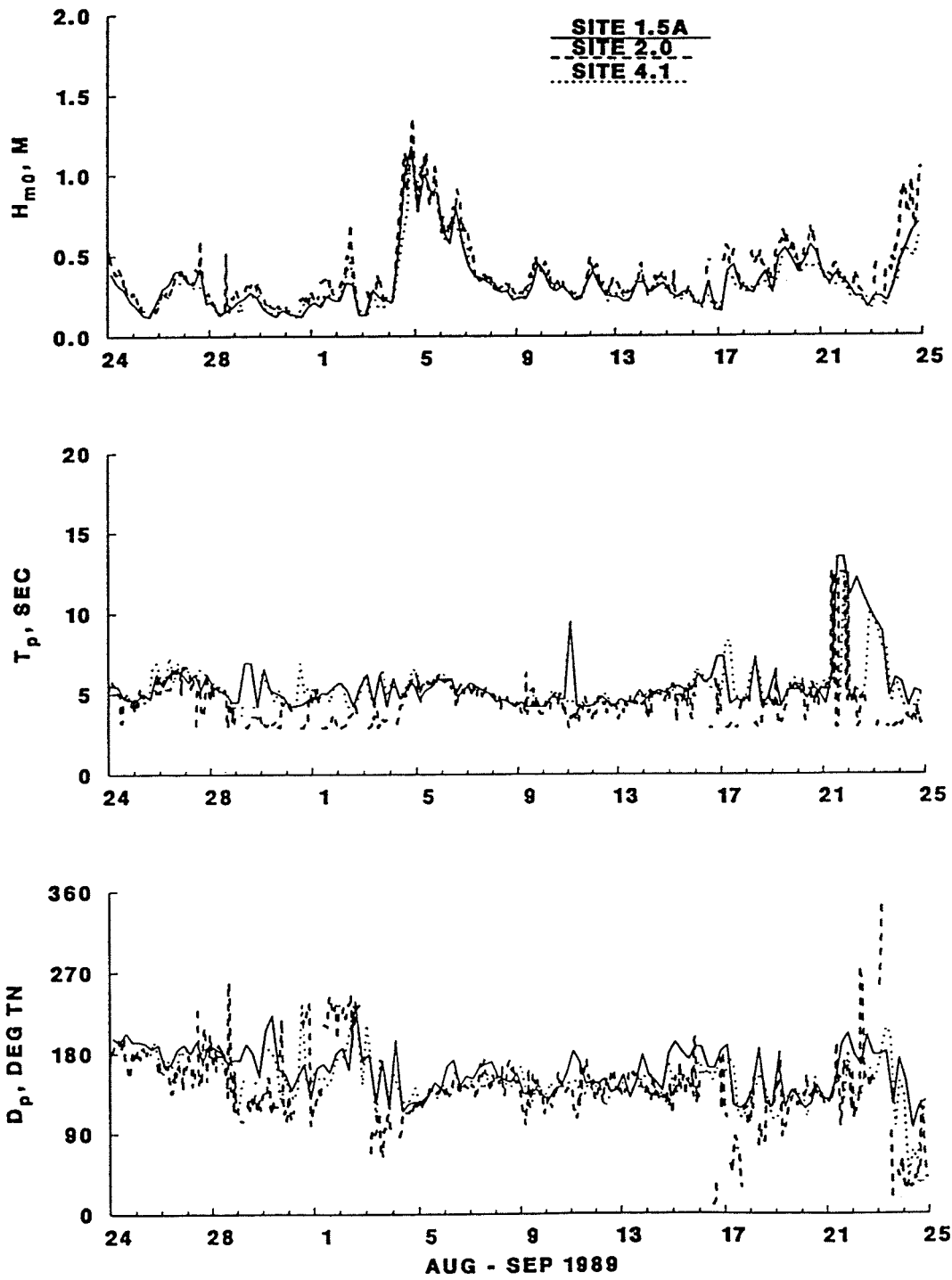

Appendix A

Sensor Specifications

Pressure sensors - a model 245AT digiquartz pressure gauge manufactured by Paroscientific, Inc., Redmond, WA, uses a crystal line resonator to detect pressure-induced stress by means of changes in the oscillating frequency. Pressure applied to a bellows generates the force that changes the resonant frequency of the crystal. Self-contained electronics provide a frequency output.

Current sensor - The current meter consists of a 4-in. sphere which creates a magnetic field. The magnetic field, created by an AC electromagnet within the sphere, is produced so as to be parallel to the support shaft of the current meter. Electrodes in the wall of the sphere detect the induced voltages in a plane perpendicular to the flow probe's axis. Two pairs of electrodes are used so that the velocity vector can be resolved into its two components, u and v . Since the instrument has essentially cosine response, the flow magnitude and direction can be reconstructed. The voltages present across the two electrode pairs are of the same carrier frequency as the magnet drive frequency and have amplitudes that are proportional to the flow component detected by each pair. In the electronics package, this AC signal is amplified, synchronously detected, and finally filtered to yield two analog voltages that represent the two components of water flow in a plane perpendicular to the flow probe axis.

Sensor Specifications	
Paroscientific Pressure Gauge - Model 254A	
Pressure range	0 - 45 PSIA
Repeatability	± 0.005% full scale
Hysteresis	± 0.005% full scale
Acceleration sensitivity	± 0.0038% full scale/g
Power requirement	6 - 35 V DC
Current	0.002 amp
Output	4-V square wave
Nominal frequency at zero pressure	37 - 42 KHZ
Nominal frequency at full pressure	32 - 37 KHZ
Marsh McBirney Current Meter - Model 551	
Output	± 5 V
Range	± 3 m/sec
Accuracy	± 0.02 m/sec
Linearity	± 2%
Output time constant	0.25 sec
Output impedance	100 ohms
Input voltage	± 12 V DC
Power	< .030 amp

Appendix B

Reduced Data

This appendix contains reduced data in the form of tabular listings and time-series plots of each available data set. These listings contain directional wave and current statistics for each wave burst interval. A wave burst consists of 1,024 samples of 1 Hz of instantaneous pressure, x component of velocity, and y component of velocity. For convenience, since the x and y components are referenced to the (arbitrary) instrument orientation, u and v components aligned with west and north, respectively, but with axes pointing inward, are computed from the instantaneous resultant current vector.

The parameters in the directional wave and current statistic listings are defined as follows:

- a. Date and time are referenced to Greenwich Mean Time (GMT)/Coordinated Universal Time (UTC).
- b. Wave height: H_{mo} (*Shore Protection Manual*, Vol II, p. B5).
- c. Peak wave period: T_p (*Shore Protection Manual*, Vol II, p. B14).
- d. Peak wave direction: D_p , direction from which waves are coming relative to north. For example, 0 indicates waves coming from the north and 90 indicates waves coming from the east. Peak direction is selected from the two-dimensional energy spectra as the direction of the frequency band with the highest wave energy.
- e. Average current magnitude: AVE.CUR - mean instantaneous water particle velocity magnitude over the burst interval. This velocity is defined as the square root of the sum of the u component of velocity squared and the v component of velocity squared. The instantaneous water particle velocity magnitudes are all positive and are averaged to compute this value. Hence, direction changes are not reflected in the "average current" and it is not a measure of net water motion at the gauge.

- f. Maximum current magnitude: MAX CUR - maximum current velocity of a 1-sec sample over the burst interval.
- g. Median current magnitude: MED CUR - median instantaneous water particle velocity of the sorted magnitudes over the burst interval.
- h. Standard deviation of current magnitude: STDV - the standard deviation of the instantaneous water particle velocities over the burst interval.
- i. Mean u-velocity vector magnitude: UMEAN - this statistic is calculated by summing all *u*-velocities measured over a single sample period, maintaining sign and dividing by the number of velocities summed.
- j. Mean v-velocity vector magnitude: VMEAN - this statistic is calculated by summing all *v*-velocities measured over a single sample period, maintaining sign and dividing by the number of velocities summed.
- k. Current direction: CUR DIR - current direction calculated using the resultant of the UMEAN and VMEAN velocity vectors. It is the direction in degrees TOWARD WHICH the current is flowing. Figure A1 indicates the relationship between compass direction, *u* and *v* values, and current sensor coordinate system. Current direction for *u* mean = 0.08 and *v* mean = 0.03 m/sec is plotted as an example.

Water depth: DEPTH - depth to seafloor at sensor location. This statistic is calculated by converting the mean water pressure to mean water depth above the gauge and then adding the pressure sensor elevation above the seafloor. The current meter elevation is approximately 1.4 m above the seafloor for the self-contained gauge deployments. For the real-time gauges, the current meter elevation is approximately 0.4 m above the seafloor.

Time series plots are of:

Wave statistics - Hmo, Tp, Dp

Current statistics - Mean current direction, mean current velocity, and water depth

The complete 100-MB ASCII data set, containing:

PUV record files of raw time series = *.ASC
 Wave and current statistic files = *.OUT
 Analysis parameter files = *IN.DAT
 Directional wave analysis program = PUV_MOB.FOR

Directional spectra listing program = PUV_MOB_LIST.FOR
where * denotes the data set name

is available upon request from the Dredging Research Program Manager. It includes a copy of the backup listing describing how the backup was generated and what steps are necessary to extract files from the save set. It includes a description of procedures for processing directional spectra using the provided *.ASC, *.IN.DAT files, and the analysis and listing programs. An example listing of the directional spectra is also provided.

Data editing: All raw data, pressure, u velocity, and v velocity data were checked for data spikes. These spikes were removed and replaced by linear interpolation whenever the spikes were isolated or with record means if spikes occurred in sequence. Analyzed records failing quality assurance procedures were omitted.

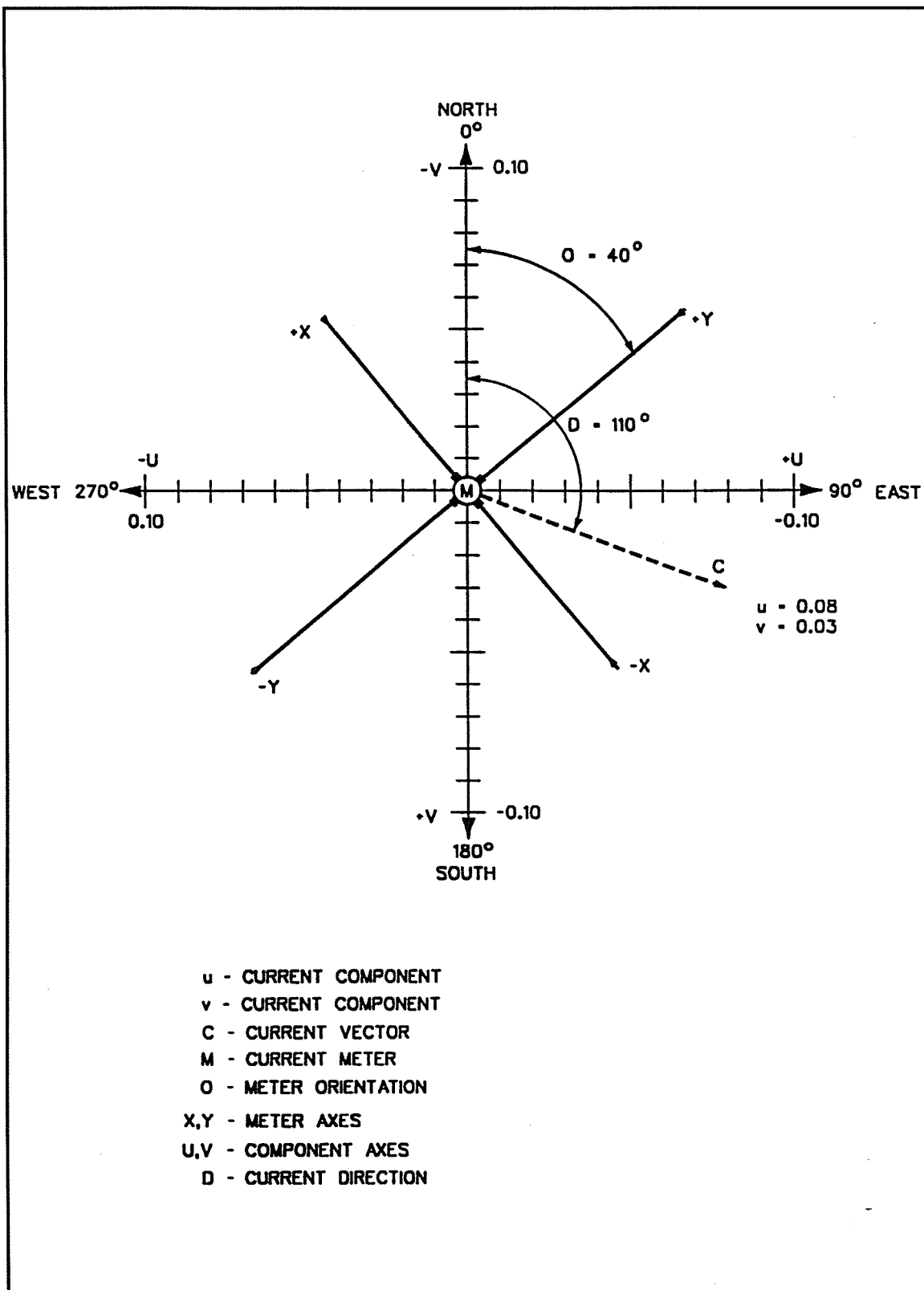
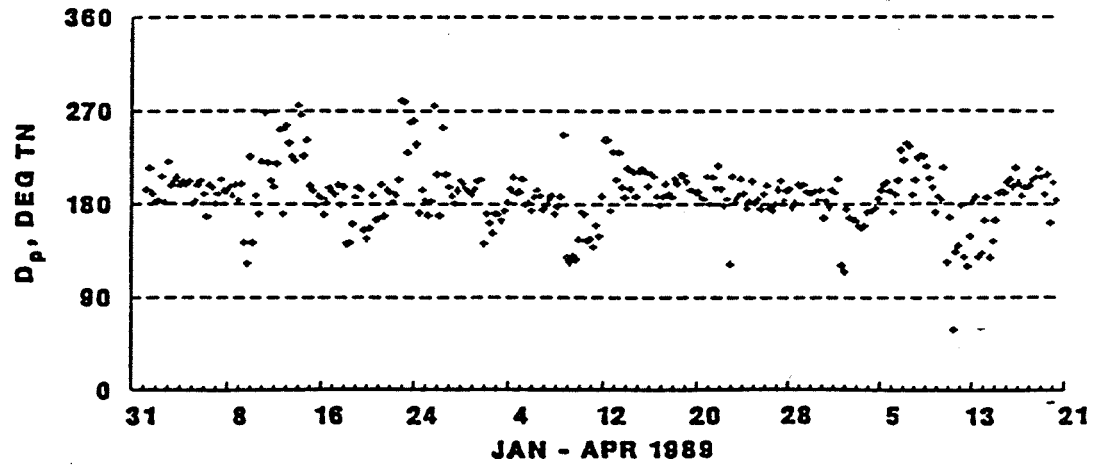
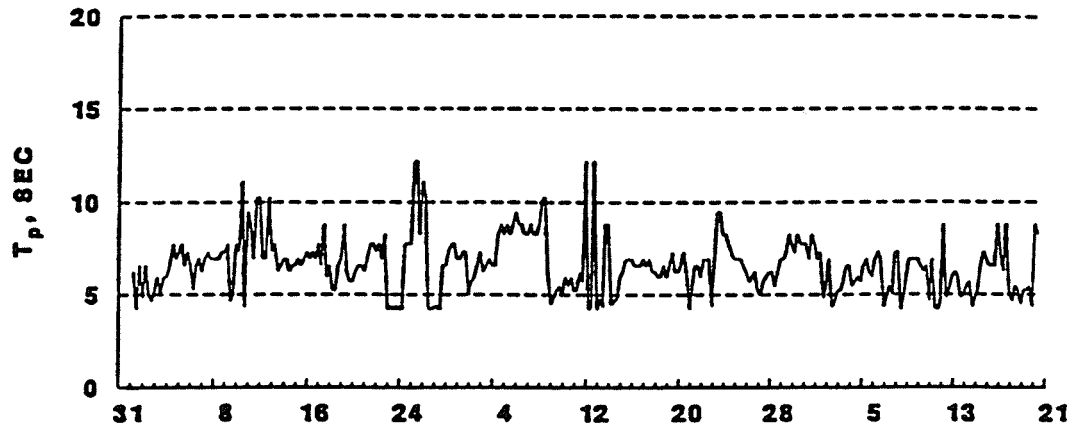
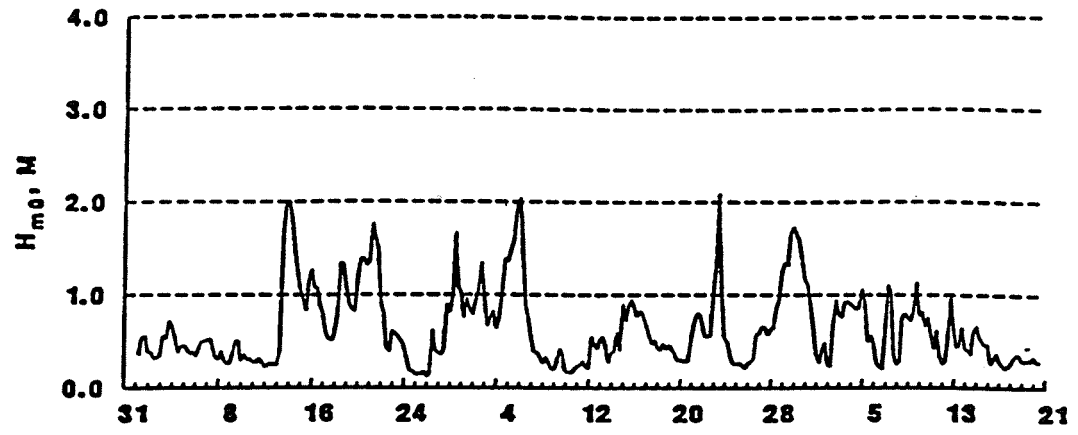

Figure B1. Relationship between current sensor orientation, compass direction, and u and v components

**MOBILE, ALABAMA
SITE 1.5, 30.175 N, 88.067 W**



JAN - APR 1989

**MOBILE, ALABAMA
SITE 1.5, 30.175 N, 88.067 W**

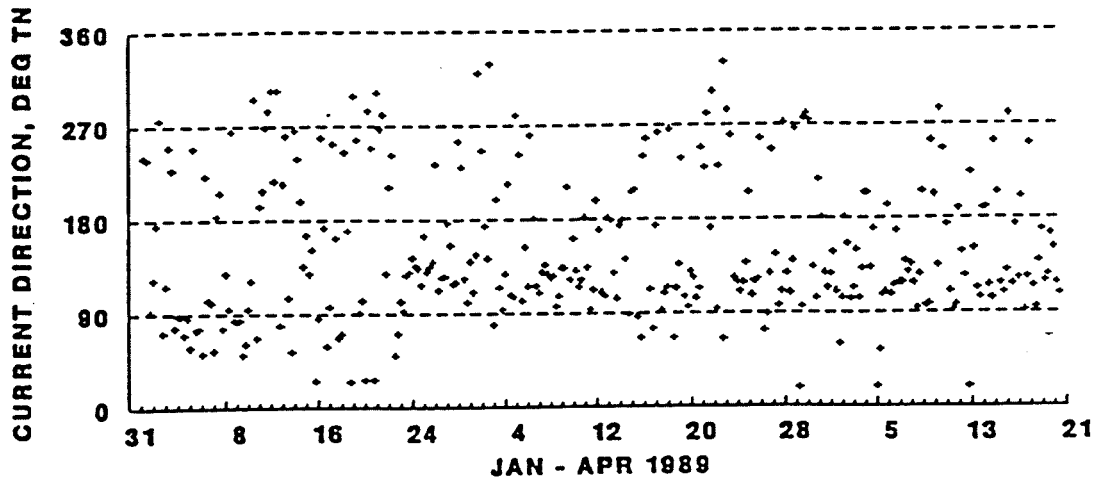
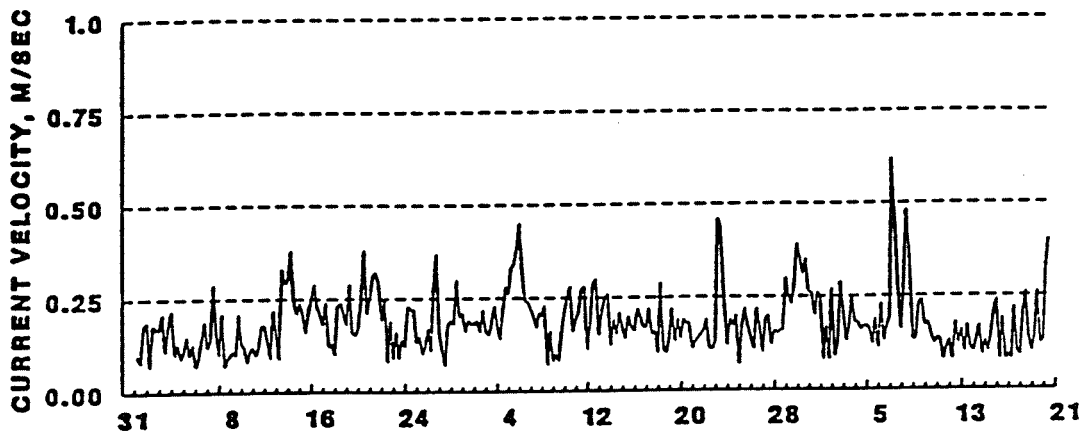
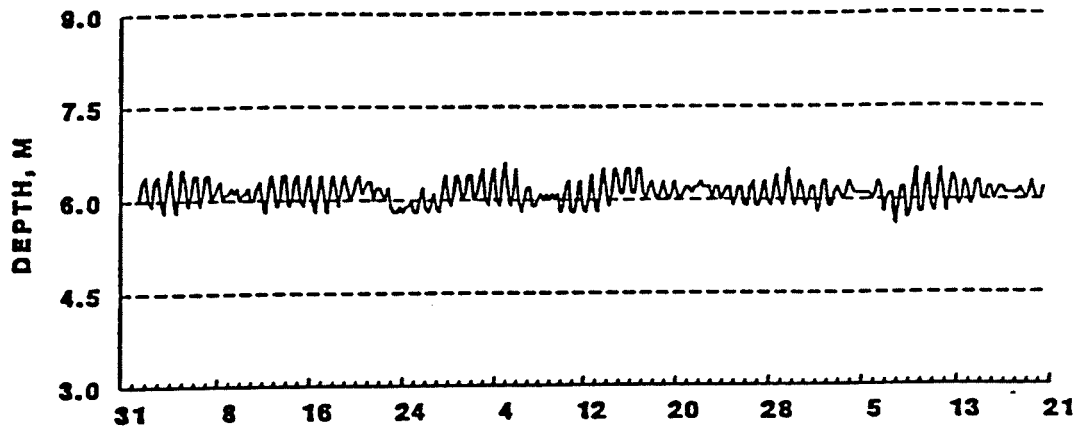

MOBILE, ALABAMA
 SITE 1.5A
 30.175 N, 88.067 W

ANALYSIS SUMMARY
 PUV Version 3.4
 12-SEP-91

MM	DY	YR	HRMN (GHT)	HmO (M)	TP (SEC)	Dp (DEG)	AVE.CUR (H/SEC)	MAX.CUR (H/SEC)	MED.CUR (H/SEC)	STDV (H/SEC)	UHEAN (H/SEC)	VHEAN (H/SEC)	C.DIR (DEG)	DEPTH (M)
1	31	89	1745	0.50	6.92	187	0.12	0.34	0.12	0.06	0.08	-0.01	79	6.3
1	31	89	2345	0.40	7.31	201	0.09	0.28	0.08	0.05	-0.03	0.02	228	6.4
2	1	89	545	0.36	6.24	194	0.10	0.30	0.09	0.05	-0.06	0.03	240	6.0
2	1	89	1145	0.55	4.20	215	0.08	0.28	0.08	0.05	-0.03	0.02	238	6.0
2	1	89	1745	0.56	6.56	190	0.18	0.31	0.18	0.04	0.17	0.01	92	6.3
2	1	89	2345	0.39	4.83	183	0.19	0.36	0.19	0.04	0.16	0.10	123	6.4
2	2	89	545	0.38	6.56	184	0.07	0.20	0.06	0.04	0.00	0.04	175	6.0
2	2	89	1145	0.31	5.02	207	0.18	0.28	0.18	0.03	-0.17	-0.02	276	5.9
2	2	89	1745	0.33	4.65	181	0.17	0.32	0.17	0.05	0.16	-0.05	72	6.3
2	2	89	2345	0.35	5.22	221	0.17	0.27	0.17	0.03	0.14	0.07	117	6.4
2	3	89	545	0.57	5.95	198	0.21	0.51	0.21	0.07	-0.18	0.06	250	6.0
2	3	89	1145	0.53	5.02	202	0.11	0.39	0.10	0.05	-0.02	0.02	228	5.8
2	3	89	1745	0.72	5.95	206	0.18	0.46	0.17	0.08	0.13	-0.03	77	6.2
2	3	89	2345	0.66	5.95	198	0.22	0.45	0.22	0.07	0.19	0.00	88	6.5
2	4	89	545	0.55	6.56	202	0.10	0.32	0.10	0.05	0.06	0.00	88	6.1
2	4	89	1145	0.38	7.76	199	0.13	0.35	0.12	0.08	0.09	-0.03	70	5.8
2	4	89	1745	0.45	6.92	202	0.09	0.28	0.09	0.05	0.05	0.00	86	6.1
2	4	89	2345	0.46	7.31	180	0.11	0.29	0.11	0.05	0.07	-0.04	58	6.5
2	5	89	545	0.42	7.76	183	0.15	0.34	0.15	0.06	-0.11	0.04	249	6.3
2	5	89	1145	0.36	6.56	198	0.10	0.29	0.09	0.05	0.03	-0.01	75	5.9
2	5	89	1745	0.39	7.31	203	0.13	0.35	0.13	0.05	0.11	-0.03	76	6.1
2	5	89	2345	0.34	6.56	190	0.07	0.23	0.07	0.04	0.03	-0.02	52	6.4
2	6	89	545	0.41	5.22	168	0.09	0.24	0.08	0.04	-0.03	0.04	222	6.4
2	6	89	1145	0.50	6.56	198	0.14	0.35	0.13	0.06	0.09	0.02	103	5.9
2	6	89	1745	0.50	6.92	196	0.19	0.38	0.19	0.06	0.16	-0.03	101	6.1
2	6	89	2345	0.52	6.24	180	0.12	0.35	0.11	0.06	0.06	-0.04	55	6.4
2	7	89	545	0.53	6.92	190	0.14	0.42	0.13	0.07	-0.01	0.11	184	6.4
2	7	89	1145	0.45	7.31	204	0.29	0.59	0.29	0.09	-0.13	0.26	206	6.0
2	7	89	1745	0.32	6.92	193	0.16	0.30	0.16	0.04	0.15	-0.04	76	6.1
2	7	89	2345	0.31	6.92	193	0.10	0.24	0.10	0.04	0.06	0.05	129	6.2
2	8	89	545	0.40	6.92	197	0.21	0.36	0.21	0.04	0.20	0.02	95	6.3
2	8	89	1145	0.29	6.92	188	0.07	0.24	0.06	0.04	-0.04	0.00	265	6.0
2	8	89	1745	0.26	7.31	199	0.09	0.19	0.09	0.03	0.08	-0.01	84	6.1
2	8	89	2345	0.26	7.31	184	0.10	0.21	0.10	0.03	0.09	-0.01	83	6.1
2	9	89	545	0.35	7.76	200	0.11	0.19	0.11	0.03	0.10	-0.01	84	6.2
2	9	89	1145	0.51	4.65	143	0.10	0.24	0.10	0.04	0.06	-0.05	51	6.1
2	9	89	1745	0.50	5.02	123	0.21	0.56	0.21	0.08	0.16	-0.09	61	6.2
2	9	89	2345	0.29	7.76	226	0.13	0.28	0.13	0.04	0.11	0.01	95	6.0
2	10	89	545	0.36	7.31	143	0.12	0.30	0.11	0.05	0.09	0.06	122	6.1
2	10	89	1145	0.30	11.13	189	0.08	0.24	0.07	0.04	-0.04	-0.02	296	6.1
2	10	89	1745	0.31	4.34	171	0.11	0.22	0.11	0.04	0.09	-0.04	67	6.2
2	10	89	2345	0.27	9.48	221	0.12	0.34	0.11	0.06	-0.03	0.10	193	6.0
2	11	89	545	0.27	8.83	268	0.10	0.33	0.10	0.05	-0.03	0.05	208	6.0
2	11	89	1145	0.31	6.92	220	0.12	0.27	0.13	0.05	-0.09	0.00	269	6.2
2	11	89	1745	0.28	10.24	203	0.18	0.44	0.18	0.06	-0.12	-0.04	285	6.3

MOBILE, ALABAMA
 SITE 1.5A
 30.175 N, 88.067 W

ANALYSIS SUMMARY
 PUV Version 3.4
 12-SEP-91

MM	DY	YR	HRMN (GMT)	Hm0 (M)	Tp (SEC)	Dp (DEG)	AVE.CUR (M/SEC)	MAX.CUR (M/SEC)	MED.CUR (M/SEC)	STDV (M/SEC)	UMEAN (M/SEC)	VMEAN (M/SEC)	C.DIR (DEG)	DEPTH (M)
2	11	89	2345	0.22	10.24	197	0.18	0.72	0.16	0.10	-0.08	-0.05	304	6.0
2	12	89	545	0.25	6.92	219	0.14	0.36	0.14	0.06	-0.07	0.10	217	5.8
2	12	89	1145	0.26	6.92	252	0.09	0.25	0.09	0.04	-0.03	-0.02	304	6.1
2	12	89	1745	0.25	10.24	171	0.22	0.53	0.21	0.10	0.07	-0.01	79	6.4
2	12	89	2345	0.25	7.31	256	0.16	0.39	0.15	0.06	-0.08	0.12	214	6.2
2	13	89	545	0.39	7.76	239	0.09	0.25	0.09	0.04	-0.05	0.01	261	5.9
2	13	89	1145	1.69	6.24	226	0.33	0.91	0.31	0.16	0.16	0.05	106	6.0
2	13	89	1745	1.99	6.56	222	0.29	0.78	0.27	0.16	0.10	-0.07	54	6.4
2	13	89	2345	2.00	6.92	275	0.30	0.81	0.28	0.15	-0.11	0.01	266	6.4
2	14	89	545	1.80	6.92	266	0.38	0.89	0.36	0.19	-0.18	0.11	239	5.9
2	14	89	1145	1.49	6.24	227	0.25	0.66	0.24	0.13	-0.02	0.06	198	6.0
2	14	89	1745	1.27	6.56	242	0.21	0.71	0.19	0.11	0.03	0.04	136	6.3
2	14	89	2345	1.05	6.56	198	0.24	0.83	0.20	0.15	0.04	0.16	166	6.4
2	15	89	545	0.95	6.92	193	0.21	0.72	0.19	0.12	0.07	0.06	129	6.0
2	15	89	1145	0.83	6.56	179	0.16	0.51	0.15	0.09	0.02	0.05	152	5.9
2	15	89	1745	1.15	6.92	188	0.21	0.69	0.19	0.12	0.03	-0.05	26	6.2
2	15	89	2345	1.27	7.31	186	0.25	0.85	0.23	0.15	0.10	-0.01	86	6.4
2	16	89	545	1.08	6.92	170	0.29	0.73	0.28	0.13	-0.20	0.04	259	6.0
2	16	89	1145	1.08	7.31	182	0.23	0.79	0.21	0.13	0.01	0.08	173	5.8
2	16	89	1745	0.90	6.92	196	0.21	0.61	0.19	0.11	0.10	-0.06	59	6.1
2	16	89	2345	0.79	7.76	192	0.18	0.55	0.18	0.09	0.11	0.01	97	6.4
2	17	89	545	0.59	6.56	190	0.24	0.51	0.24	0.08	-0.20	0.06	253	6.1
2	17	89	1145	0.52	8.83	199	0.12	0.47	0.11	0.07	0.01	0.04	163	5.8
2	17	89	1745	0.51	5.95	179	0.13	0.40	0.12	0.06	0.07	-0.03	67	6.1
2	17	89	2345	0.58	6.56	197	0.10	0.32	0.10	0.06	0.02	-0.01	71	6.4
2	18	89	545	0.76	5.22	142	0.23	0.54	0.23	0.09	-0.17	0.08	245	6.2
2	18	89	1145	1.35	5.22	143	0.24	0.81	0.21	0.14	0.02	0.11	170	5.9
2	18	89	1745	1.32	6.56	161	0.21	0.63	0.19	0.12	0.03	-0.05	25	6.2
2	18	89	2345	1.09	6.92	187	0.18	0.68	0.16	0.11	-0.02	-0.01	299	6.4
2	19	89	545	0.91	8.83	196	0.29	0.69	0.28	0.10	-0.23	0.05	257	6.2
2	19	89	1145	0.85	6.24	194	0.16	0.50	0.15	0.09	0.04	0.00	91	6.0
2	19	89	1745	0.82	5.69	155	0.15	0.53	0.13	0.08	0.03	0.01	103	6.1
2	19	89	2345	1.14	5.69	147	0.17	0.54	0.16	0.09	0.01	-0.02	27	6.3
2	20	89	545	1.39	6.24	157	0.24	0.64	0.22	0.12	-0.08	-0.02	285	6.4
2	20	89	1145	1.39	6.56	189	0.38	0.89	0.36	0.15	-0.27	0.10	249	6.1
2	20	89	1745	1.32	6.56	165	0.21	0.67	0.19	0.12	0.02	-0.05	27	6.2
2	20	89	2345	1.36	6.24	166	0.25	0.64	0.23	0.13	-0.08	-0.05	302	6.3
2	21	89	545	1.76	6.92	199	0.31	0.93	0.27	0.19	-0.06	0.00	267	6.3
2	21	89	1145	1.62	7.76	169	0.32	0.94	0.29	0.19	-0.06	-0.01	281	6.0
2	21	89	1745	1.48	7.76	194	0.29	0.83	0.27	0.16	-0.02	0.01	129	6.2
2	21	89	2345	0.92	7.31	192	0.19	0.62	0.16	0.11	-0.04	0.07	211	6.2
2	22	89	545	0.80	7.76	183	0.25	0.63	0.24	0.11	-0.17	0.09	242	6.1
2	22	89	1145	0.43	6.92	189	0.08	0.26	0.08	0.04	0.04	-0.03	50	6.0
2	22	89	1745	0.39	8.26	204	0.19	0.33	0.19	0.04	0.18	-0.06	71	6.2
2	22	89	2345	0.61	4.20	280	0.09	0.29	0.09	0.05	0.06	0.01	102	5.9

MOBILE, ALABAMA
 SITE 1.5A
 30.175 N, 88.067 W

ANALYSIS SUMMARY
 PUV Version 3.4
 12-SEP-91

MM	DY	YR	HRHN (GMT)	Hm0 (M)	Tp (SEC)	Dp (DEG)	AVE.CUR (M/SEC)	MAX.CUR (M/SEC)	MED.CUR (M/SEC)	STDV (M/SEC)	U-MEAN (M/SEC)	V-MEAN (M/SEC)	C.DIR (DEG)	DEPTH (M)
2	23	89	545	0.58	4.34	279	0.16	0.35	0.16	0.06	0.15	0.01	93	5.8
2	23	89	1145	0.55	4.20	230	0.09	0.22	0.10	0.04	0.07	0.05	127	5.8
2	23	89	1745	0.51	4.34	259	0.14	0.27	0.14	0.05	0.10	0.09	130	5.9
2	23	89	2345	0.46	4.20	261	0.12	0.25	0.12	0.04	0.07	0.09	144	5.8
2	24	89	545	0.31	4.20	238	0.23	0.37	0.23	0.04	0.16	0.16	136	5.9
2	24	89	1145	0.19	7.76	172	0.22	0.31	0.22	0.03	0.15	0.15	134	5.9
2	24	89	1745	0.18	7.76	194	0.22	0.32	0.22	0.03	0.19	0.11	118	6.0
2	24	89	2345	0.14	7.76	184	0.13	0.21	0.13	0.03	0.03	0.12	165	5.8
2	25	89	545	0.15	12.19	169	0.15	0.24	0.15	0.03	0.11	0.09	130	5.8
2	25	89	1145	0.15	12.19	183	0.10	0.21	0.10	0.03	0.07	0.07	135	6.0
2	25	89	1745	0.17	8.26	275	0.12	0.26	0.12	0.03	0.08	0.09	140	6.2
2	25	89	2345	0.11	11.13	209	0.17	0.25	0.17	0.03	-0.14	0.10	233	5.9
2	26	89	545	0.17	10.24	169	0.11	0.19	0.11	0.03	0.10	0.04	113	5.8
2	26	89	1145	0.62	4.20	254	0.28	0.41	0.29	0.05	0.22	0.16	125	5.9
2	26	89	1745	0.40	4.20	209	0.37	0.50	0.37	0.04	0.30	0.22	126	6.1
2	26	89	2345	0.37	4.34	197	0.16	0.31	0.17	0.05	0.01	0.16	177	5.9
2	27	89	545	0.36	4.34	188	0.11	0.23	0.10	0.04	0.04	0.09	156	5.8
2	27	89	1145	0.42	4.20	181	0.07	0.19	0.06	0.03	0.03	0.02	119	6.1
2	27	89	1745	0.90	6.56	193	0.18	0.51	0.17	0.09	0.09	0.05	120	6.4
2	27	89	2345	0.81	6.56	203	0.19	0.65	0.18	0.10	-0.14	0.04	255	6.1
2	28	89	545	0.99	7.31	200	0.18	0.67	0.16	0.11	-0.03	0.02	230	5.9
2	28	89	1145	1.67	7.76	195	0.30	0.97	0.28	0.16	0.02	0.01	124	6.1
2	28	89	1745	1.08	7.76	192	0.20	0.67	0.18	0.11	0.01	0.00	101	6.4
2	28	89	2345	1.03	6.92	189	0.21	0.80	0.19	0.12	0.04	0.05	140	6.3
3	1	89	545	0.76	6.92	195	0.16	0.59	0.15	0.10	0.03	0.01	111	6.0
3	1	89	1145	0.96	7.31	203	0.19	0.53	0.17	0.11	0.03	0.05	147	6.1
3	1	89	1745	0.85	7.31	204	0.18	0.53	0.17	0.09	-0.07	-0.09	320	6.4
3	1	89	2345	0.79	5.02	142	0.18	0.43	0.18	0.07	-0.13	0.06	246	6.4
3	2	89	545	0.93	5.69	171	0.19	0.59	0.17	0.10	0.01	0.13	174	6.0
3	2	89	1145	1.07	5.95	162	0.16	0.65	0.15	0.09	0.04	0.05	143	6.1
3	2	89	1745	1.35	6.56	152	0.22	0.63	0.20	0.12	-0.04	-0.07	329	6.3
3	2	89	2345	1.00	7.31	171	0.16	0.60	0.15	0.09	0.05	-0.01	79	6.5
3	3	89	545	0.67	6.24	170	0.15	0.55	0.15	0.08	-0.03	0.09	199	6.0
3	3	89	1145	0.76	6.56	165	0.18	0.49	0.17	0.08	0.10	0.05	115	5.9
3	3	89	1745	0.83	6.92	174	0.23	0.64	0.23	0.10	0.17	0.01	94	6.3
3	3	89	2345	0.64	6.56	182	0.18	0.47	0.17	0.08	0.11	0.09	128	6.5
3	4	89	545	0.74	6.56	195	0.14	0.46	0.13	0.08	-0.02	0.03	214	6.0
3	4	89	1145	1.00	8.26	206	0.21	0.72	0.19	0.12	0.06	0.02	108	5.9
3	4	89	1745	1.39	8.83	191	0.28	0.77	0.27	0.16	0.07	0.02	106	6.3
3	4	89	2345	1.36	8.26	192	0.26	0.87	0.24	0.14	-0.06	-0.01	280	6.6
3	5	89	545	1.49	8.83	204	0.33	0.87	0.29	0.18	-0.10	0.05	242	6.2
3	5	89	1145	1.59	8.26	179	0.34	0.89	0.31	0.18	0.04	0.01	102	5.9
3	5	89	1745	1.96	8.83	182	0.38	1.03	0.37	0.19	0.04	0.08	154	6.1
3	5	89	2345	2.05	9.48	174	0.45	1.04	0.43	0.21	0.16	0.08	116	6.5
3	6	89	545	1.55	8.83	187	0.33	0.95	0.30	0.18	-0.06	0.01	261	6.0

MOBILE, ALABAMA
 SITE 1.5A
 30.175 N, 88.067 W

ANALYSIS SUMMARY
 PUV Version 3.4
 12-SEP-91

MM	DY	YR	HRMN (GHT)	Hm0 (M)	TP (SEC)	Dp (DEG)	AVE.CUR (M/SEC)	MAX.CUR (M/SEC)	MED.CUR (M/SEC)	STDV (M/SEC)	UMEAN (M/SEC)	VMEAN (M/SEC)	C.DIR (DEG)	DEPTH (M)
3	6	89	1145	0.89	8.83	194	0.24	0.79	0.22	0.14	0.00	0.14	181	5.8
3	6	89	1745	0.75	8.26	189	0.24	0.72	0.24	0.09	0.17	0.09	117	6.0
3	6	89	2345	0.54	8.26	175	0.22	0.43	0.22	0.07	0.17	0.07	110	6.2
3	7	89	545	0.39	8.83	179	0.20	0.38	0.19	0.06	0.14	0.12	130	6.2
3	7	89	1145	0.38	8.26	184	0.17	0.40	0.16	0.06	0.10	0.11	137	5.9
3	7	89	1745	0.34	8.26	189	0.21	0.38	0.21	0.05	0.16	0.13	128	5.9
3	7	89	2345	0.26	8.83	171	0.20	0.35	0.20	0.04	0.16	0.11	124	6.0
3	8	89	545	0.33	10.24	178	0.23	0.36	0.23	0.04	0.19	0.14	126	6.1
3	8	89	1145	0.27	10.24	188	0.07	0.17	0.07	0.03	0.06	0.01	97	6.0
3	8	89	1745	0.20	6.24	247	0.16	0.24	0.15	0.03	0.15	0.05	107	6.1
3	8	89	2345	0.20	4.49	129	0.08	0.17	0.08	0.03	0.05	0.05	134	6.0
3	9	89	545	0.27	4.83	124	0.10	0.23	0.10	0.04	0.07	0.07	134	6.1
3	9	89	1145	0.42	5.22	131	0.08	0.25	0.08	0.04	-0.03	0.05	211	6.0
3	9	89	1745	0.36	5.45	127	0.15	0.36	0.15	0.06	0.13	0.08	123	6.1
3	9	89	2345	0.18	5.02	146	0.21	0.32	0.21	0.03	0.06	0.20	162	5.8
3	10	89	545	0.16	5.95	173	0.25	0.35	0.25	0.03	0.19	0.16	131	5.9
3	10	89	1145	0.16	5.45	171	0.28	0.36	0.28	0.03	0.25	0.13	116	6.2
3	10	89	1745	0.20	5.95	145	0.16	0.29	0.16	0.04	0.13	0.09	123	6.3
3	10	89	2345	0.23	5.22	147	0.19	0.32	0.19	0.04	-0.01	0.19	182	5.8
3	11	89	545	0.24	5.22	139	0.21	0.36	0.21	0.04	0.15	0.15	135	5.8
3	11	89	1145	0.29	6.24	160	0.27	0.41	0.27	0.04	0.27	0.02	94	6.0
3	11	89	1745	0.22	5.69	150	0.28	0.46	0.28	0.05	0.25	0.11	113	6.3
3	11	89	2345	0.21	12.19	188	0.11	0.23	0.11	0.04	-0.03	0.10	198	5.9
3	12	89	545	0.55	4.20	242	0.18	0.36	0.18	0.05	0.03	0.17	170	5.8
3	12	89	1145	0.47	4.34	242	0.29	0.43	0.29	0.04	0.26	0.10	110	6.0
3	12	89	1745	0.42	12.19	174	0.30	0.40	0.31	0.04	0.29	0.09	107	6.4
3	12	89	2345	0.51	4.20	231	0.15	0.33	0.15	0.05	-0.01	0.14	182	6.0
3	13	89	545	0.55	4.83	204	0.21	0.48	0.20	0.07	0.00	0.20	179	5.8
3	13	89	1145	0.46	4.34	230	0.25	0.37	0.25	0.04	0.19	0.16	129	6.1
3	13	89	1745	0.27	8.83	197	0.26	0.36	0.27	0.03	0.25	0.06	104	6.5
3	13	89	2345	0.38	8.83	187	0.12	0.29	0.12	0.05	0.01	0.11	174	6.2
3	14	89	545	0.39	4.49	215	0.19	0.41	0.19	0.05	0.00	0.19	179	5.9
3	14	89	1145	0.60	4.65	195	0.15	0.36	0.15	0.06	0.08	0.11	142	6.1
3	14	89	1745	0.40	4.83	211	0.21	0.32	0.21	0.04	0.20	0.00	89	6.5
3	14	89	2345	0.90	5.95	188	0.17	0.64	0.14	0.10	-0.05	0.10	206	6.4
3	15	89	545	0.72	6.24	212	0.14	0.42	0.12	0.08	-0.02	0.03	208	6.1
3	15	89	1145	0.88	6.92	214	0.20	0.60	0.19	0.10	0.12	-0.01	86	6.1
3	15	89	1745	0.95	6.92	212	0.17	0.53	0.15	0.10	0.06	-0.03	66	6.5
3	15	89	2345	0.87	6.92	198	0.16	0.49	0.15	0.09	-0.06	0.03	240	6.5
3	16	89	545	0.77	6.56	209	0.22	0.67	0.22	0.10	-0.17	0.04	257	6.1
3	16	89	1145	0.83	6.56	207	0.20	0.60	0.20	0.09	0.13	0.06	113	6.1
3	16	89	1745	0.78	6.56	188	0.17	0.57	0.16	0.09	0.10	-0.03	75	6.5
3	16	89	2345	0.69	6.92	179	0.17	0.49	0.16	0.09	0.01	0.15	174	6.5
3	17	89	545	0.58	6.56	187	0.22	0.52	0.22	0.07	-0.19	0.02	263	6.1
3	17	89	1145	0.47	6.92	200	0.15	0.32	0.15	0.05	0.13	0.01	93	6.0

MOBILE, ALABAMA
 SITE 1.5A
 30.175 N, 88.067 W

ANALYSIS SUMMARY
 PUV Version 3.4
 12-SEP-91

MM	DY	YR	HRMN (GHT)	HmO (M)	TP (SEC)	Dp (DEG)	AVE.CUR (M/SEC)	MAX.CUR (M/SEC)	MED.CUR (M/SEC)	STDV (M/SEC)	UMEAN (M/SEC)	VMEAN (M/SEC)	C.DIR (DEG)	DEPTH (M)
3	17	89	1745	0.51	6.24	191	0.16	0.35	0.16	0.05	0.14	0.05	109	6.2
3	17	89	2345	0.43	6.24	187	0.10	0.29	0.10	0.04	0.07	0.03	115	6.3
3	18	89	545	0.40	5.95	205	0.29	0.44	0.29	0.04	-0.28	0.02	266	6.1
3	18	89	1145	0.47	5.95	200	0.11	0.31	0.11	0.05	0.07	-0.03	66	6.0
3	18	89	1745	0.42	6.56	209	0.10	0.27	0.10	0.04	0.07	0.03	114	6.1
3	18	89	2345	0.46	5.95	208	0.14	0.32	0.14	0.05	0.08	0.09	137	6.3
3	19	89	545	0.41	6.56	202	0.22	0.45	0.22	0.07	-0.17	0.11	238	6.1
3	19	89	1145	0.37	7.31	194	0.13	0.27	0.13	0.04	0.10	0.03	106	6.0
3	19	89	1745	0.29	6.24	194	0.19	0.29	0.19	0.03	0.18	0.02	96	6.1
3	19	89	2345	0.30	6.24	191	0.14	0.28	0.14	0.04	0.10	0.08	130	6.3
3	20	89	545	0.28	6.56	192	0.19	0.31	0.18	0.03	0.15	0.10	124	6.1
3	20	89	1145	0.28	7.31	186	0.18	0.28	0.18	0.03	0.17	0.04	104	6.0
3	20	89	1745	0.31	6.24	185	0.18	0.26	0.18	0.03	0.16	0.07	114	6.1
3	20	89	2345	0.53	4.20	207	0.11	0.23	0.11	0.04	-0.09	0.04	248	6.2
3	21	89	545	0.68	5.45	180	0.13	0.41	0.13	0.07	-0.06	0.05	229	6.2
3	21	89	1145	0.80	6.56	206	0.14	0.47	0.12	0.08	-0.01	0.00	281	6.1
3	21	89	1745	0.79	6.56	196	0.15	0.46	0.13	0.08	0.01	0.07	172	6.2
3	21	89	2345	0.70	5.95	217	0.16	0.47	0.15	0.07	-0.08	-0.05	302	6.2
3	22	89	545	0.56	6.92	195	0.19	0.42	0.19	0.06	0.17	0.01	94	6.3
3	22	89	1145	0.55	6.92	178	0.11	0.39	0.11	0.06	-0.06	0.05	231	6.2
3	22	89	1745	0.57	6.92	185	0.11	0.31	0.11	0.05	0.06	-0.03	65	6.2
3	22	89	2345	1.00	4.34	122	0.13	0.38	0.12	0.07	-0.02	-0.04	330	6.2
3	23	89	545	1.31	6.92	207	0.46	0.79	0.46	0.14	-0.39	-0.10	284	6.0
3	23	89	1145	2.09	9.48	182	0.44	1.04	0.42	0.22	-0.09	0.01	260	6.2
3	23	89	1745	1.03	9.48	188	0.25	0.83	0.24	0.13	0.08	0.05	124	6.2
3	23	89	2345	0.53	8.28	204	0.12	0.44	0.11	0.07	0.01	0.00	120	6.0
3	24	89	545	0.49	8.26	191	0.19	0.37	0.19	0.05	0.16	0.06	111	6.1
3	24	89	1145	0.34	7.76	176	0.17	0.38	0.17	0.04	0.14	0.08	119	6.2
3	24	89	1745	0.26	7.31	183	0.20	0.34	0.20	0.04	0.13	0.15	138	6.2
3	24	89	2345	0.25	6.92	202	0.07	0.22	0.06	0.04	-0.02	0.04	205	5.9
3	25	89	545	0.27	6.92	181	0.17	0.28	0.17	0.04	0.16	0.05	107	6.0
3	25	89	1145	0.24	6.92	185	0.22	0.35	0.22	0.04	0.19	0.11	121	6.2
3	25	89	1745	0.21	6.56	175	0.17	0.30	0.17	0.03	0.14	0.09	123	6.2
3	25	89	2345	0.26	6.24	190	0.14	0.26	0.14	0.03	-0.13	0.03	257	5.9
3	26	89	545	0.28	5.69	198	0.11	0.22	0.11	0.03	0.10	-0.03	73	5.9
3	26	89	1145	0.31	5.95	176	0.22	0.32	0.22	0.03	0.22	0.00	89	6.2
3	26	89	1745	0.58	6.24	174	0.17	0.38	0.16	0.06	0.12	0.09	128	6.3
3	26	89	2345	0.58	5.22	180	0.10	0.32	0.09	0.05	-0.04	0.02	246	5.9
3	27	89	545	0.66	5.02	194	0.19	0.44	0.18	0.08	0.10	0.14	146	5.9
3	27	89	1145	0.65	5.69	203	0.20	0.42	0.20	0.06	0.17	0.02	97	6.1
3	27	89	1745	0.57	5.95	184	0.12	0.31	0.12	0.05	0.09	0.03	111	6.3
3	27	89	2345	0.62	6.24	193	0.16	0.42	0.16	0.07	-0.13	-0.01	272	6.0
3	28	89	545	0.65	6.24	195	0.15	0.41	0.15	0.07	0.09	0.07	128	5.9
3	28	89	1145	0.86	5.45	177	0.16	0.41	0.16	0.07	0.11	0.04	109	6.1
3	28	89	1745	0.95	6.24	181	0.16	0.52	0.15	0.09	0.05	0.06	140	6.4

MOBILE, ALABAMA
 SITE 1.5A
 30.175 N, 88.067 W

ANALYSIS SUMMARY
 PUV Version 3.4
 12-SEP-91

MM	DY	YR	HRMN (GMT)	HmO (M)	Tp (SEC)	Dp (DEG)	AVE.CUR (M/SEC)	MAX.CUR (M/SEC)	MED.CUR (M/SEC)	STDV (M/SEC)	UMEAN (M/SEC)	VMEAN (M/SEC)	C.DIR (DEG)	DEPTH (M)
3	28	89	2345	1.25	6.92	199	0.30	0.79	0.28	0.14	-0.19	0.01	266	6.1
3	29	89	545	1.35	6.92	198	0.25	0.81	0.22	0.15	0.01	-0.02	18	5.9
3	29	89	1145	1.32	7.31	199	0.23	0.65	0.21	0.13	0.02	0.00	96	6.1
3	29	89	1745	1.67	8.26	192	0.28	0.76	0.26	0.15	-0.07	-0.01	276	6.5
3	29	89	2345	1.73	7.76	191	0.39	0.80	0.38	0.15	-0.25	-0.05	281	6.2
3	30	89	545	1.66	7.31	191	0.35	0.94	0.33	0.17	-0.18	-0.02	274	5.9
3	30	89	1145	1.59	8.26	193	0.31	0.94	0.28	0.17	0.05	0.05	134	6.0
3	30	89	1745	1.41	7.76	184	0.35	0.86	0.33	0.15	0.20	0.05	104	6.3
3	30	89	2345	1.17	7.76	194	0.26	0.83	0.24	0.15	-0.07	0.09	217	6.2
3	31	89	545	1.10	7.76	167	0.26	0.88	0.24	0.15	-0.01	0.20	181	5.9
3	31	89	1145	0.90	6.92	183	0.20	0.62	0.18	0.10	0.09	0.08	128	6.0
3	31	89	1745	0.65	8.26	177	0.26	0.51	0.27	0.07	0.22	0.10	114	6.2
3	31	89	2345	0.36	7.76	194	0.25	0.38	0.25	0.05	0.20	0.15	127	6.2
4	1	89	545	0.27	6.92	191	0.08	0.32	0.08	0.04	0.03	0.05	148	5.8
4	1	89	1145	0.40	7.31	204	0.17	0.28	0.17	0.04	0.16	0.06	110	5.9
4	1	89	1745	0.48	4.83	121	0.08	0.23	0.08	0.04	0.04	-0.02	60	6.3
4	1	89	2345	0.24	5.45	115	0.27	0.41	0.27	0.04	0.26	0.07	104	6.3
4	2	89	545	0.23	6.92	175	0.09	0.22	0.09	0.04	0.00	0.08	181	5.9
4	2	89	1145	0.69	4.34	167	0.12	0.45	0.12	0.07	0.04	0.10	156	5.9
4	2	89	1745	0.95	4.65	165	0.29	0.67	0.28	0.08	0.26	0.06	103	6.1
4	2	89	2345	0.78	5.22	164	0.21	0.50	0.21	0.09	0.17	0.08	114	6.2
4	3	89	545	0.76	5.22	159	0.13	0.49	0.12	0.07	0.03	0.06	150	6.1
4	3	89	1145	0.92	5.69	157	0.17	0.46	0.16	0.08	0.06	0.02	104	6.0
4	3	89	1745	0.93	6.56	159	0.25	0.68	0.24	0.12	0.16	0.15	132	6.1
4	3	89	2345	0.90	6.56	172	0.18	0.53	0.17	0.10	-0.04	0.10	204	6.3
4	4	89	545	0.88	5.45	173	0.18	0.65	0.16	0.10	-0.06	0.12	204	6.2
4	4	89	1145	0.84	5.69	174	0.16	0.45	0.15	0.08	0.06	0.06	133	6.1
4	4	89	1745	0.87	5.95	176	0.17	0.63	0.16	0.09	0.01	0.09	170	6.1
4	4	89	2345	1.06	5.69	185	0.17	0.59	0.15	0.10	0.01	-0.02	19	6.1
4	5	89	545	0.93	6.56	193	0.16	0.49	0.15	0.09	0.04	-0.03	54	6.1
4	5	89	1145	0.49	6.92	199	0.12	0.32	0.11	0.06	0.06	0.02	107	6.1
4	5	89	1745	0.56	6.24	201	0.19	0.42	0.19	0.06	0.15	0.05	110	6.1
4	5	89	2345	0.47	5.95	192	0.11	0.38	0.10	0.06	-0.01	0.06	192	6.0
4	6	89	545	0.27	6.92	172	0.23	0.33	0.23	0.03	0.22	0.07	107	6.1
4	6	89	1145	0.22	7.31	189	0.13	0.25	0.13	0.03	0.11	0.06	116	6.3
4	6	89	1745	0.20	6.92	203	0.17	0.30	0.17	0.04	0.03	0.16	168	6.2
4	6	89	2345	0.57	4.34	232	0.19	0.37	0.19	0.04	0.15	0.09	119	5.8
4	7	89	545	1.10	4.83	222	0.62	0.91	0.61	0.10	0.46	0.26	119	6.0
4	7	89	1145	1.03	5.45	238	0.46	0.75	0.46	0.08	0.29	0.34	139	6.1
4	7	89	1745	0.36	5.02	236	0.27	0.39	0.27	0.04	0.20	0.17	129	6.1
4	7	89	2345	0.25	7.31	189	0.16	0.29	0.16	0.03	0.11	0.11	136	5.6
4	8	89	545	0.28	7.31	203	0.29	0.40	0.29	0.03	0.25	0.13	118	5.9
4	8	89	1145	0.76	4.20	225	0.48	0.65	0.47	0.06	0.47	0.03	94	6.2
4	8	89	1745	0.80	4.83	227	0.35	0.55	0.35	0.06	0.27	0.20	126	6.2
4	8	89	2345	0.75	5.95	226	0.13	0.40	0.11	0.07	-0.02	0.04	205	5.7

MOBILE, ALABAMA
 SITE 1.5A
 30.175 N, 88.067 W

ANALYSIS SUMMARY
 PUV Version 3.4
 12-SEP-91

MM	DY	YR	HRHN (GHT)	Hm0 (M)	Tp (SEC)	Dp (DEG)	AVE.CUR (M/SEC)	MAX.CUR (M/SEC)	MED.CUR (M/SEC)	STDV (M/SEC)	UMEAN (M/SEC)	VMEAN (M/SEC)	C.DIR (DEG)	DEPTH (M)
4	9	89	545	0.72	6.92	216	0.14	0.42	0.13	0.07	0.05	0.01	97	5.0
4	9	89	1145	0.84	6.92	205	0.23	0.56	0.23	0.09	0.18	0.03	98	6.2
4	9	89	1745	1.13	6.92	196	0.24	0.63	0.23	0.11	-0.18	0.05	254	6.5
4	9	89	2345	0.78	6.92	172	0.17	0.55	0.15	0.10	-0.03	0.08	202	5.8
4	10	89	545	0.82	6.56	187	0.18	0.50	0.17	0.10	0.07	0.07	135	5.8
4	10	89	1145	0.66	6.24	184	0.15	0.35	0.15	0.06	-0.11	-0.03	285	6.2
4	10	89	1745	0.76	6.56	215	0.12	0.30	0.12	0.06	-0.08	0.04	246	6.4
4	10	89	2345	0.57	4.65	124	0.14	0.34	0.14	0.06	0.01	0.13	174	5.9
4	11	89	545	0.42	6.92	167	0.13	0.27	0.13	0.04	0.11	0.04	110	5.8
4	11	89	1145	0.61	4.20	59	0.08	0.27	0.08	0.04	0.06	0.00	92	6.1
4	11	89	1745	0.36	4.20	134	0.11	0.22	0.11	0.03	0.10	0.01	97	6.5
4	11	89	2345	0.26	4.65	140	0.13	0.25	0.13	0.04	-0.02	0.12	189	6.1
4	12	89	545	0.28	8.83	178	0.08	0.19	0.07	0.04	0.04	0.06	148	5.8
4	12	89	1145	0.50	4.83	129	0.18	0.33	0.18	0.06	0.14	0.10	125	6.1
4	12	89	1745	0.97	5.22	120	0.12	0.39	0.11	0.07	0.02	-0.05	19	6.4
4	12	89	2345	0.64	5.95	149	0.16	0.42	0.16	0.06	-0.09	-0.09	223	6.3
4	13	89	545	0.44	6.24	183	0.10	0.32	0.09	0.06	0.03	0.06	151	5.9
4	13	89	1145	0.46	5.95	187	0.17	0.31	0.17	0.05	0.15	0.06	113	6.0
4	13	89	1745	0.65	4.83	129	0.11	0.30	0.10	0.05	0.06	0.02	104	6.3
4	13	89	2345	0.41	5.02	133	0.10	0.31	0.10	0.05	-0.01	0.07	189	6.2
4	14	89	545	0.41	5.45	164	0.13	0.30	0.13	0.06	-0.02	0.12	190	5.9
4	14	89	1145	0.36	5.69	186	0.17	0.32	0.17	0.04	0.14	0.07	116	6.0
4	14	89	1745	0.60	4.34	128	0.09	0.29	0.09	0.05	0.06	0.01	103	6.3
4	14	89	2345	0.67	4.83	144	0.13	0.36	0.13	0.05	-0.09	0.03	253	6.3
4	15	89	545	0.55	5.22	164	0.10	0.33	0.10	0.05	-0.02	0.04	204	6.0
4	15	89	1145	0.50	6.56	191	0.14	0.35	0.14	0.05	0.10	0.06	118	6.0
4	15	89	1745	0.46	7.31	192	0.21	0.38	0.21	0.05	0.18	0.06	109	6.2
4	15	89	2345	0.47	6.92	191	0.24	0.44	0.23	0.06	0.17	0.14	130	6.2
4	16	89	545	0.26	6.56	201	0.08	0.20	0.08	0.03	-0.05	-0.01	280	6.0
4	16	89	1145	0.31	6.56	204	0.19	0.33	0.19	0.04	0.16	0.08	117	6.1
4	16	89	1745	0.37	6.56	197	0.08	0.24	0.08	0.04	0.01	0.06	174	6.2
4	16	89	2345	0.29	8.83	215	0.09	0.22	0.09	0.04	0.07	0.04	123	6.2
4	17	89	545	0.24	7.31	200	0.08	0.24	0.08	0.04	-0.02	0.06	200	6.1
4	17	89	1145	0.21	6.24	188	0.22	0.34	0.22	0.03	0.22	0.01	92	6.1
4	17	89	1745	0.23	8.83	196	0.10	0.25	0.10	0.05	0.07	0.05	124	6.1
4	17	89	2345	0.26	5.02	196	0.09	0.20	0.09	0.03	-0.08	0.03	251	6.1
4	18	89	545	0.31	4.65	198	0.20	0.37	0.20	0.04	0.18	0.08	115	6.1
4	18	89	1145	0.36	5.45	204	0.26	0.37	0.26	0.03	0.25	0.03	95	6.2
4	18	89	1745	0.35	5.22	206	0.14	0.30	0.14	0.04	0.09	0.10	139	6.1
4	18	89	2345	0.29	4.49	214	0.10	0.23	0.10	0.04	0.02	0.09	169	6.0
4	19	89	545	0.28	5.22	207	0.14	0.25	0.14	0.03	0.11	0.07	120	6.1
4	19	89	1145	0.30	5.22	190	0.26	0.41	0.26	0.04	0.21	0.16	126	6.3
4	19	89	1745	0.29	5.45	209	0.12	0.32	0.12	0.05	0.03	0.10	165	6.1
4	19	89	2345	0.34	4.34	162	0.13	0.29	0.13	0.04	0.06	0.11	132	6.0
4	20	89	545	0.27	8.83	201	0.32	0.45	0.32	0.04	0.28	0.15	118	6.0

Appendix C

Statistical Comparison of Adjacent Gauges

The following are residual statistics from duplicate gages deployed offshore Mobile, Alabama at Site 1.5. The statistics below are results of value at Site 1.5A minus value at Site 1.5B.

MM DD YY HRMN	dHmo (M)	dTp (SEC)	dDp (DEG)
6 28 89 900	-0.01	0.00	0.0
6 28 89 1500	0.00	0.00	0.0
6 28 89 2100	-0.01	0.00	0.0
6 29 89 300	-0.01	0.55	19.0
6 29 89 900	0.01	0.00	1.0
6 29 89 1500	0.01	0.00	0.0
6 29 89 2100	0.00	0.00	3.0
6 30 89 300	0.00	0.00	-1.0
6 30 89 900	-0.01	-0.50	-10.0
6 30 89 1500	0.01	0.00	3.0
6 30 89 2100	0.00	0.00	-1.0
7 1 89 300	0.00	0.00	-1.0
7 1 89 900	-0.01	0.00	-2.0
7 1 89 1500	0.01	0.00	1.0
7 1 89 2100	0.00	0.00	-3.0
7 2 89 300	0.00	0.96	19.0
7 2 89 900	0.00	0.00	1.0
7 2 89 1500	0.01	0.00	7.0
7 2 89 2100	-0.02	0.00	5.0
7 3 89 300	0.00	0.00	-3.0
7 3 89 900	0.01	-0.57	-6.0
7 3 89 1500	0.01	0.00	-3.0
7 3 89 2100	-0.01	-0.24	8.0
7 4 89 300	0.01	0.00	-1.0
7 4 89 900	-0.01	0.00	1.0
7 4 89 1500	-0.01	0.00	-5.0
7 4 89 2100	-0.02	0.00	-1.0
7 5 89 300	-0.01	-0.55	12.0
7 5 89 900	-0.02	0.00	-2.0
7 5 89 1500	0.00	0.00	-1.0
7 5 89 2100	0.01	-0.67	2.0
7 6 89 300	0.02	0.00	4.0
7 6 89 900	0.00	0.34	4.0
7 6 89 1500	-0.03	-0.53	2.0
7 6 89 2100	-0.01	0.00	0.0
7 7 89 300	-0.02	-0.31	8.0
7 7 89 900	-0.01	0.00	1.0
7 7 89 1500	0.01	0.00	3.0
7 7 89 2100	0.01	0.00	2.0
7 8 89 300	0.00	0.00	0.0
7 8 89 900	0.00	0.00	2.0
7 8 89 1500	0.00	0.00	-1.0
7 8 89 2100	0.00	0.00	-2.0
7 9 89 300	0.01	0.00	3.0
7 9 89 900	0.00	0.00	3.0
7 9 89 1500	0.00	0.00	0.0
7 9 89 2100	0.00	0.00	1.0
7 10 89 300	0.01	0.00	2.0
7 10 89 900	-0.01	0.00	-2.0
7 10 89 1500	0.00	0.00	-2.0
7 10 89 2100	0.00	0.00	1.0
7 11 89 300	0.01	0.00	1.0
7 11 89 900	0.00	0.00	2.0
7 11 89 1500	0.00	0.00	1.0
7 11 89 2100	0.00	0.00	1.0

7 28 89 300	0.00	0.00	0.0
7 28 89 900	0.00	0.00	2.0
7 28 89 1500	0.00	0.00	0.0
7 28 89 2100	0.00	0.00	-1.0
7 29 89 300	0.01	0.00	0.0
7 29 89 900	0.00	0.00	-1.0
7 29 89 1500	0.01	0.00	-1.0
7 29 89 2100	0.00	0.00	0.0
7 30 89 300	0.00	0.00	-1.0
7 30 89 900	0.00	0.00	2.0
7 30 89 1500	0.00	0.00	2.0
7 30 89 2100	0.01	0.00	0.0
7 31 89 300	0.00	0.00	0.0
7 31 89 900	0.00	0.00	-9.0
7 31 89 1500	0.02	0.00	5.0
7 31 89 2100	-0.02	0.00	17.0
8 1 89 300	0.03	0.00	5.0
8 1 89 900	0.04	0.00	11.0
8 1 89 1500	0.05	0.00	14.0
8 1 89 2100	0.05	0.00	-1.0
8 2 89 300	0.03	1.52	5.0
8 2 89 900	0.03	0.00	-1.0
8 2 89 1500	0.00	0.00	0.0
8 2 89 2100	0.01	0.00	-1.0
8 3 89 300	0.00	0.00	-1.0
8 3 89 900	0.01	0.00	-1.0
8 3 89 1500	0.00	0.00	-5.0
8 3 89 2100	0.01	0.00	2.0
8 4 89 300	0.01	0.00	2.0
8 4 89 900	0.00	0.00	-3.0
8 4 89 1500	0.00	0.75	5.0
8 4 89 2100	0.00	0.00	1.0
8 5 89 300	0.00	0.00	-1.0
8 5 89 900	0.00	0.00	0.0
8 5 89 1500	0.00	0.00	-6.0
8 5 89 2100	0.00	0.00	4.0
8 6 89 300	-0.01	-0.45	7.0
8 6 89 900	0.00	0.00	-5.0
8 6 89 1500	0.00	0.00	-7.0
8 6 89 2100	0.00	0.00	4.0
8 7 89 300	0.00	0.00	-4.0
8 7 89 900	-0.02	0.00	-2.0
8 7 89 1500	0.00	0.00	-1.0
8 7 89 2100	0.00	0.00	-1.0
8 8 89 300	0.01	0.00	3.0
8 8 89 900	0.02	0.00	4.0
8 8 89 1500	0.01	0.00	-5.0
8 8 89 2100	0.00	0.00	0.0
8 9 89 300	0.01	0.00	0.0
8 9 89 900	0.01	0.00	-3.0
8 9 89 1500	0.01	0.00	0.0
8 9 89 2100	0.01	0.00	0.0
8 10 89 300	0.01	0.00	-2.0
8 10 89 900	0.00	0.00	-3.0
8 10 89 1500	0.01	0.00	1.0
8 10 89 2100	0.03	0.00	-3.0
8 11 89 300	0.02	0.00	-2.0
8 11 89 900	0.01	0.00	-1.0
8 11 89 1500	0.03	0.00	-4.0
8 11 89 2100	0.02	0.00	1.0
8 12 89 300	0.01	0.00	4.0
8 12 89 900	0.02	0.00	1.0
8 12 89 1500	0.01	-0.14	-6.0
8 12 89 2100	0.04	0.00	-1.0

8 13 89 300	0.03	0.00	-2.0
8 13 89 900	0.03	0.00	-2.0
8 13 89 1500	0.06	-0.29	-10.0
8 13 89 2100	0.08	0.00	0.0
8 14 89 300	0.05	0.00	-1.0
8 14 89 900	0.03	0.00	0.0
8 14 89 1500	0.04	0.00	-1.0
8 14 89 2100	0.02	0.00	-2.0
8 15 89 300	0.02	0.00	-2.0
8 15 89 900	0.03	0.00	-3.0
8 15 89 1500	0.02	0.00	3.0
8 15 89 2100	0.05	0.00	0.0
8 16 89 300	0.02	0.00	5.0
8 16 89 900	0.03	0.00	3.0
8 16 89 1500	0.02	-1.49	17.0
8 16 89 2100	0.01	0.00	2.0
8 17 89 300	0.03	-0.82	60.0
8 17 89 900	0.01	0.00	-3.0
8 17 89 1500	0.02	0.00	5.0
8 17 89 2100	0.01	0.00	-1.0
8 18 89 300	0.02	-0.31	-9.0
8 18 89 900	0.03	0.00	3.0
8 18 89 1500	0.02	0.49	-5.0
8 18 89 2100	0.03	0.00	1.0
8 19 89 300	0.02	0.00	1.0
8 19 89 900	0.02	0.00	1.0
8 19 89 1500	0.01	0.00	-1.0
8 19 89 2100	0.00	0.00	6.0
8 20 89 300	0.00	0.00	-3.0
8 20 89 900	0.00	0.00	-4.0
8 20 89 1500	0.00	0.00	1.0

Arithmetic dDp mean (where dTp=0)	:	0.07447 degrees
Arithmetic dDp mean (all valid values)	:	0.68692 degrees
Absolute dDp mean (where dTp=0)	:	2.14894 degrees
Absolute dDp mean (all valid values)	:	3.38785 degrees
Std. Dev dDp (where dTp=0)	:	3.16564 degrees
Arithmetic dHmo mean (all valid values)	:	0.00636 meters
Absolute dHmo mean (all valid values)	:	0.01056 meters
Std. Dev dHmo (all valid values)	:	0.01649 meters
Total number of directional wave records	:	214

Appendix D

Gauge Site Name Conversion Table

Site Name Conversion Table	
Site Name, McGehee, et al.	Site Name, Hands, et al.
1.1	PUVSI-1
1.2	PUVSI-2.1
1.3	PUVSI-2.2
1.4	PUVSI-2.4
1.5	PUVSI-3
2	NDB 42015
3	NDB 42016
4.1	PUVSI-4
4.2	PUVSI-5

Appendix E

Gauge Servicing Schedule

CERC Realtime Current Meter Service Dates for Mobile, Alabama	
23 Aug 89	Platform (Gauge 4.2) and Sand Island (Gauge 4.1) operational
27 Oct 89	Replaced current meter at platform (4.2) and cleaned current meter at Sand Island (4.1)
30 Jan 90	Pod retrieved from platform (4.2) and current meter cleaned at Sand Island (4.2)
6 Jul 90	Current meter replaced at Sand Island (4.1)
31 Oct 90	Data collection ceased at Sand island (4.1)

Appendix F

Notation

Acronym/Abbreviation	Definition
AH	Amp hours
ASCII	American Standard Code for Information Interchange
BOFY	Beginning of fiscal year
CERC	Coastal Engineering Research Center
CMOS	Complimentary metal oxide semiconductor
CPO	Chief Petty Officer
CPU	Central processing unit
DC	Direct current
DRP	Dredging Research Program
EDD	Engineering Development Division
FFT	Fast Fourier Transform
FY	Fiscal year
GOES	Geostationary orbiting earth satellite
HQUSACE	Headquarters, U.S. Army Corps of Engineers
MLLW	Mean lower low water
MLW	Mean low water
NDBC	National Data Buoy Center
NOAA	National Oceanic and Atmospheric Administration
NODC	National Oceanographic Data Center
PHS	Public Health Service
PIC	Pressure interface card
PMAB	Prototype Measurement and Analysis Branch
ROM	Read only memory
RTU	Remote transmitting unit
SAM	U.S. Army Engineer District, Mobile
SAU	Serial asynchronous units
STD BUS	Standard bus
USCG	U.S. Coast Guard
VDC	Volts DC
WES	U.S. Army Engineer Waterways Experiment Station

Acronym/Abbreviation	Definition
Math Abbreviations	
T_p	Peak wave period, defined as the inverse of the peak frequency at which $S(f)$ has its maximum value
f_p	Peak frequency
θ	Mean direction ($\tan^{-1}(b_1/a_1)$)
a_1	X-component average of $D(\theta)$
b_1	Y-component average of $D(\theta)$
$D(f,\theta)$	Directional spreading function
P	Pressure
(u,v)	Two horizontal components of the orbital velocity
PUV gauge	A directional wave gauge that measures pressure (P) and two horizontal components of the orbital velocity (u,v)
i	$\sqrt{-1}$
$S(f)$	A one-dimensional sea surface spectrum
$S(f,\gamma)$	A two-dimensional sea surface spectrum
Φ_{mn}	Cross power spectrum
K	Wave number vector
X_{mn}	Difference between 2-position vectors X_m and X_n
H_m, H_n^*	Linear transfer functions with * denoting a complex conjugate
$C_{mn}(f)$	Cospectrum
$Q_{mn}(f)$	Quad spectrum

REPORT DOCUMENTATION PAGE

Form Approved
OMB No. 0704-0188

Public reporting burden for this collection of information is estimated to average 1 hour per response, including the time for reviewing instructions, searching existing data sources, gathering and maintaining the data needed, and completing and reviewing the collection of information. Send comments regarding this burden estimate or any other aspect of this collection of information, including suggestions for reducing this burden, to Washington Headquarters Services, Directorate for Information Operations and Reports, 1215 Jefferson Davis Highway, Suite 1204, Arlington, VA 22202-4302, and to the Office of Management and Budget, Paperwork Reduction Project (0704-0188), Washington, DC 20503.

1. AGENCY USE ONLY (<i>Leave blank</i>)		2. REPORT DATE September 1994	3. REPORT TYPE AND DATES COVERED Final report	
4. TITLE AND SUBTITLE Monitoring of Waves and Currents Near the Alabama Dredged Material Mounds			5. FUNDING NUMBERS WU 32467	
6. AUTHOR(S) David McGehee, James P. McKinney, William E. Grogg, Edward B. Hands				
7. PERFORMING ORGANIZATION NAME(S) AND ADDRESS(ES) U.S. Army Engineer Waterways Experiment Station 3909 Halls Ferry Road, Vicksburg, MS 39180-6199			8. PERFORMING ORGANIZATION REPORT NUMBER Technical Report DRP-94-4	
9. SPONSORING/MONITORING AGENCY NAME(S) AND ADDRESS(ES) U.S. Army Corps of Engineers Washington, DC 20314-1000			10. SPONSORING/MONITORING AGENCY REPORT NUMBER	
11. SUPPLEMENTARY NOTES Available from National Technical Information Service, 5285 Port Royal Road, Springfield, VA 22161.				
12a. DISTRIBUTION/AVAILABILITY STATEMENT Approved for public release; distribution is unlimited.			12b. DISTRIBUTION CODE	
13. ABSTRACT (<i>Maximum 200 words</i>) Wave, tide, and current data were collected at sites around two underwater mounds constructed from dredged material. Data were collected in support of a study to document the response of the mounds and assess any potential beneficial effects. A real-time monitoring system was developed, built, and installed. System design and performance are described. Results are presented and discussed. Summaries of data collected are contained in appendices.				
14. SUBJECT TERMS Currents Mounds Disposal Waves Dredge			15. NUMBER OF PAGES 87	
			16. PRICE CODE	
17. SECURITY CLASSIFICATION OF REPORT UNCLASSIFIED	18. SECURITY CLASSIFICATION OF THIS PAGE UNCLASSIFIED	19. SECURITY CLASSIFICATION OF ABSTRACT	20. LIMITATION OF ABSTRACT	

